

Autolift System

ADAPTER FÜR DUCATO X290

Art. 465113

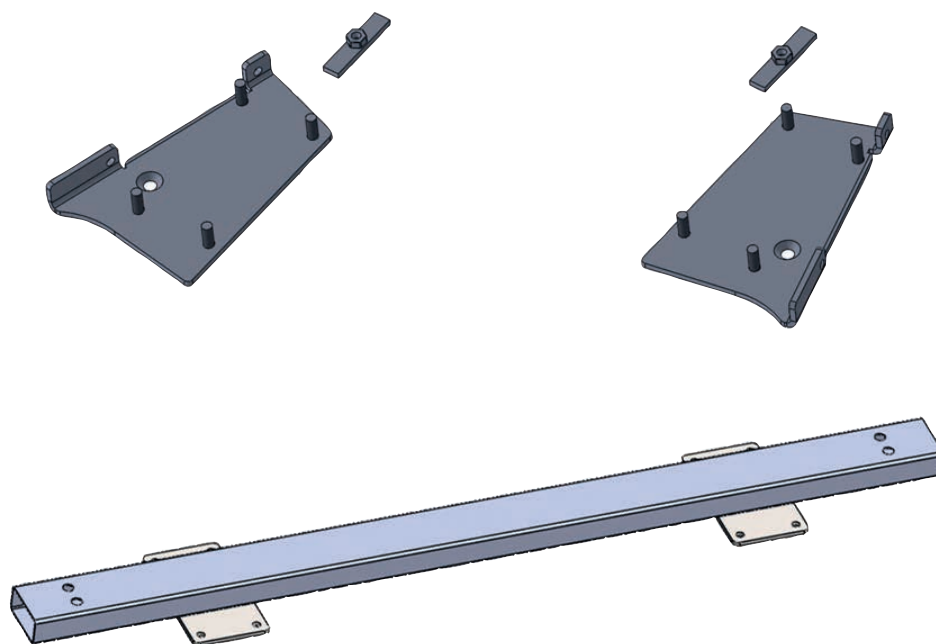

DE	-	BENUTZERHANDBUCH.....	2
EN	-	USER'S INSTRUCTION.....	11
IT	-	MANUALE D'ISTRUZIONI.....	21
ES	-	MANUAL DEL USUARIO.....	31
NL	-	INSTUCTIEHANDLEIDING.....	41
FR	-	MANUEL D'UTILISATION.....	51
FI	-	KÄYTTÖOHJE.....	61
DK	-	BRUGERHÅNDBOG.....	71
SE	-	ANVÄNDARMANUAL.....	81

FRONTADAPTER DUCATO X290

SCHRITT 1:



Entfernen Sie den Gummistopfen.

SCHRITT 2:



Setzen Sie die Montageplatte in das quadratische Loch ein.

SCHRITT 3:

Setzen Sie die Montageplatte so ein, dass das Gewinde konzentrisch zum Vierkantloch sitzt.

SCHRITT 4:

Schieben Sie den Adapter so weit wie möglich nach vorne.

SCHRITT 5:

Befestigen Sie den Adapter mit der Montageplatte, die Sie in die Bohrung eingesetzt haben.

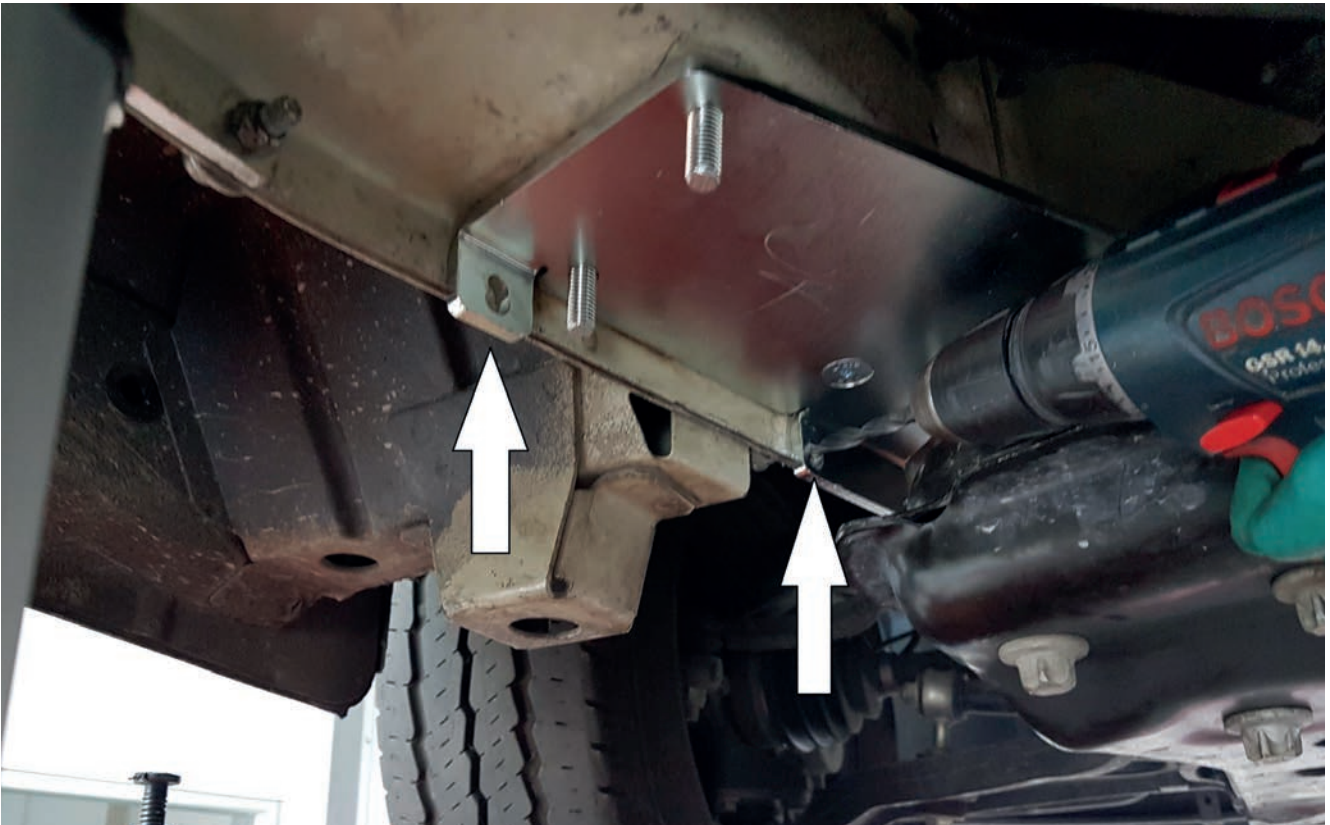
SCHRITT 6:

Bohren Sie zwei 8-mm-Löcher.

SCHRITT 7:

Montieren Sie die Adapterplatte mit zwei M8-Schrauben am Fahrzeuggestell.

SCHRITT 8:

Falls erforderlich, lösen Sie die Schrauben, die den Tank halten, und verschieben Sie ihn einige Zentimeter in Richtung Fahrzeugmitte.

ACHTUNG:

DER MOTOR MUSS IMMER ZUR FAHRZEUGMITTE ZEIGEN, WÄHREND ER SICH NACH HINTEN BEWEGT.

Heckadapter Ducato X250 (vor der Hinterachse)

SCHRITT 1:

Der hintere Adapter muss vor der Hinterachse angebracht werden, an der Stelle (siehe Fotos).

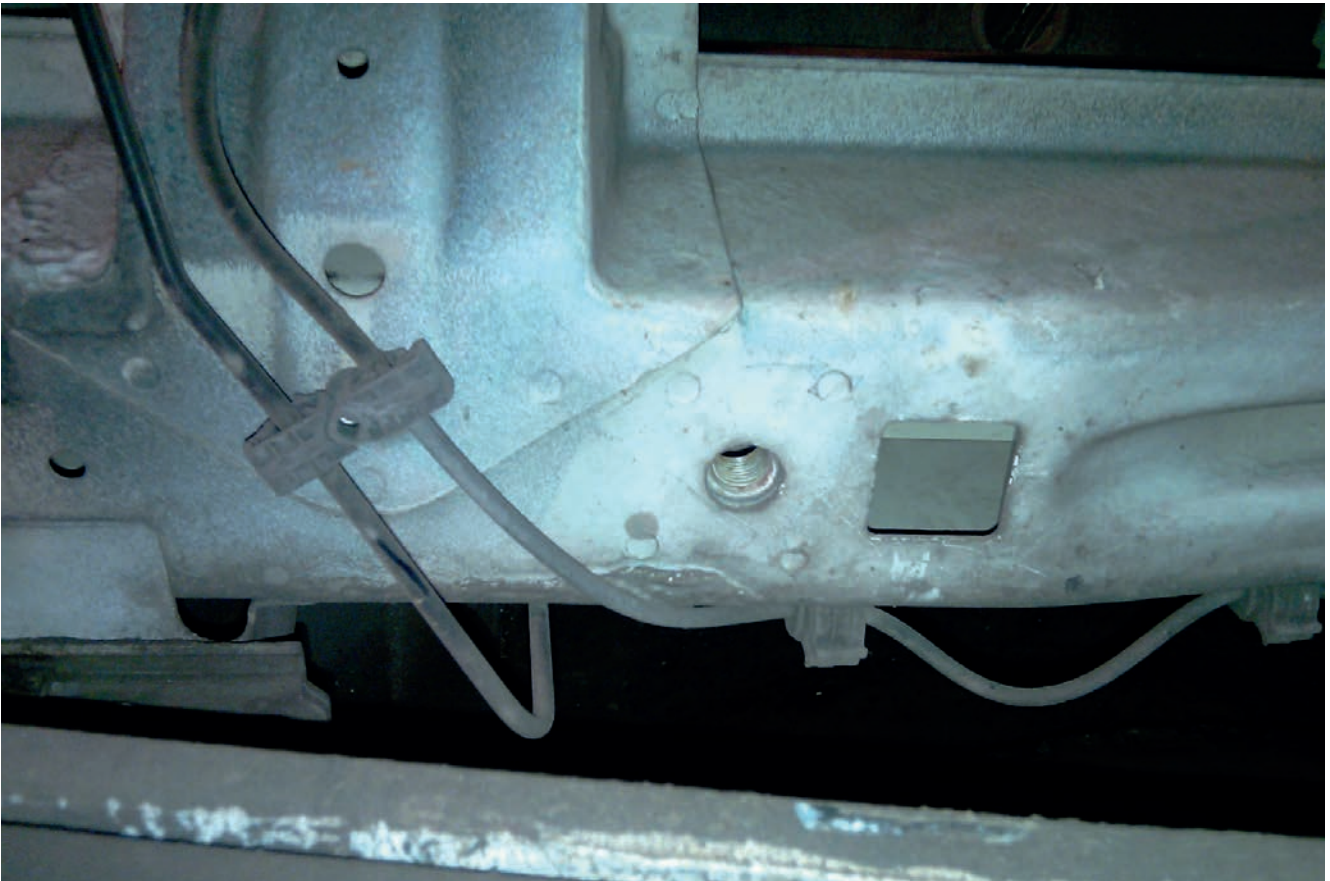

SCHRITT 2:

Setzen Sie die Montageplatte (die Platte mit nur einem Loch) ein und befestigen Sie sie mit den Schrauben 10 x 70 mm und 14 x 70 mm.

ACHTUNG: DIE BEIDEN HINTEREN MOTOREN MÜSSEN ZUR FAHRZEUGMITTE ZEIGEN, WÄHREND SIE SICH NACH VORNE BEWEGEN.

SCHRITT 3:

Der hintere Adapter muss hinter der Hinterachse an der auf den Fotos unten gezeigten Stelle platziert werden. Setzen Sie die Montageplatten (mit zwei Löchern) ein und achten Sie auf die elektrische Verkabelung; verschieben Sie diese gegebenenfalls und setzen Sie den Adapter in sie ein (siehe zweites Foto unten).





Schieben Sie die elektrische Verkabelung zur Seite und setzen Sie dann den Adapter ein.



SCHRITT 4:

Befestigen Sie den Adapter mit 4 Schrauben 10 x 70 mm, befestigen Sie dann die Wagenheber.

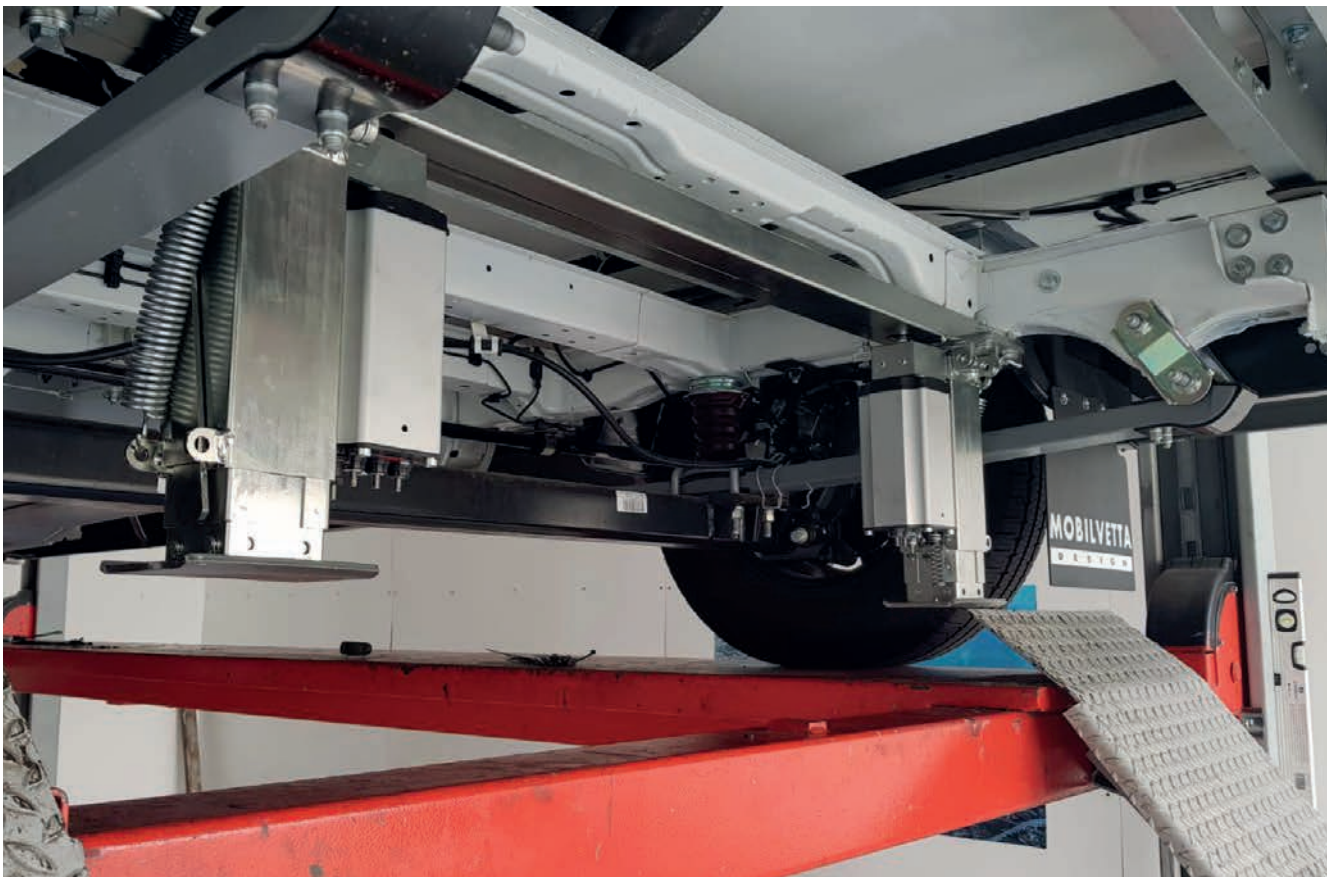

ACHTUNG: DIE BEIDEN HINTEREN MOTOREN MÜSSEN ZUR MITTE DES FAHRZEUGS ZEIGEN, WÄHREND SIE NACH VORNE ODER HINTEN BEWEGT WERDEN.

CARBEST
INNOVATIONS FOR MOBILE LIFE

Autolift System

ADAPTER FOR DUCATO X290

Art. 465113

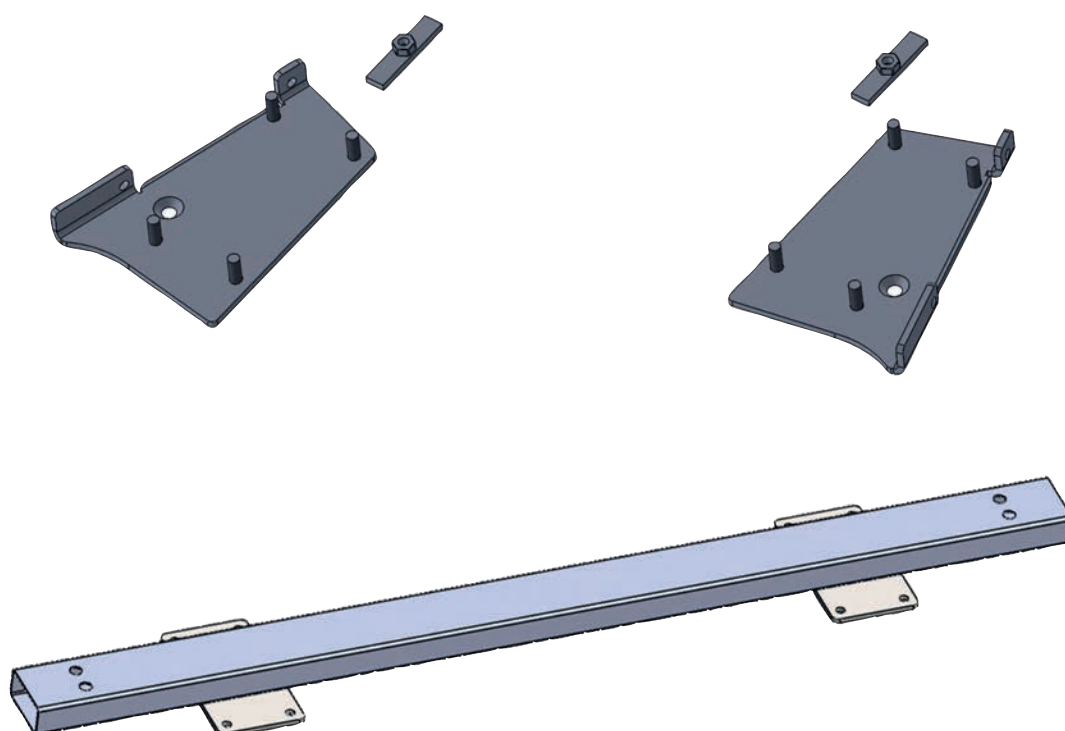

EN – USER'S INSTRUCTION.

FRONT ADAPTER DUCATO X290

STEP 1:



Remove the rubber stopper.

STEP 2:



Insert the mounting plate into the square hole.

STEP 3:

Insert the mounting plate with the screw hole concentric to the square hole in the chassis.

STEP 4:

Push the adapter as far forward as possible.

STEP 5:

Fix the adapter with the mounting plate that you inserted into the hole.

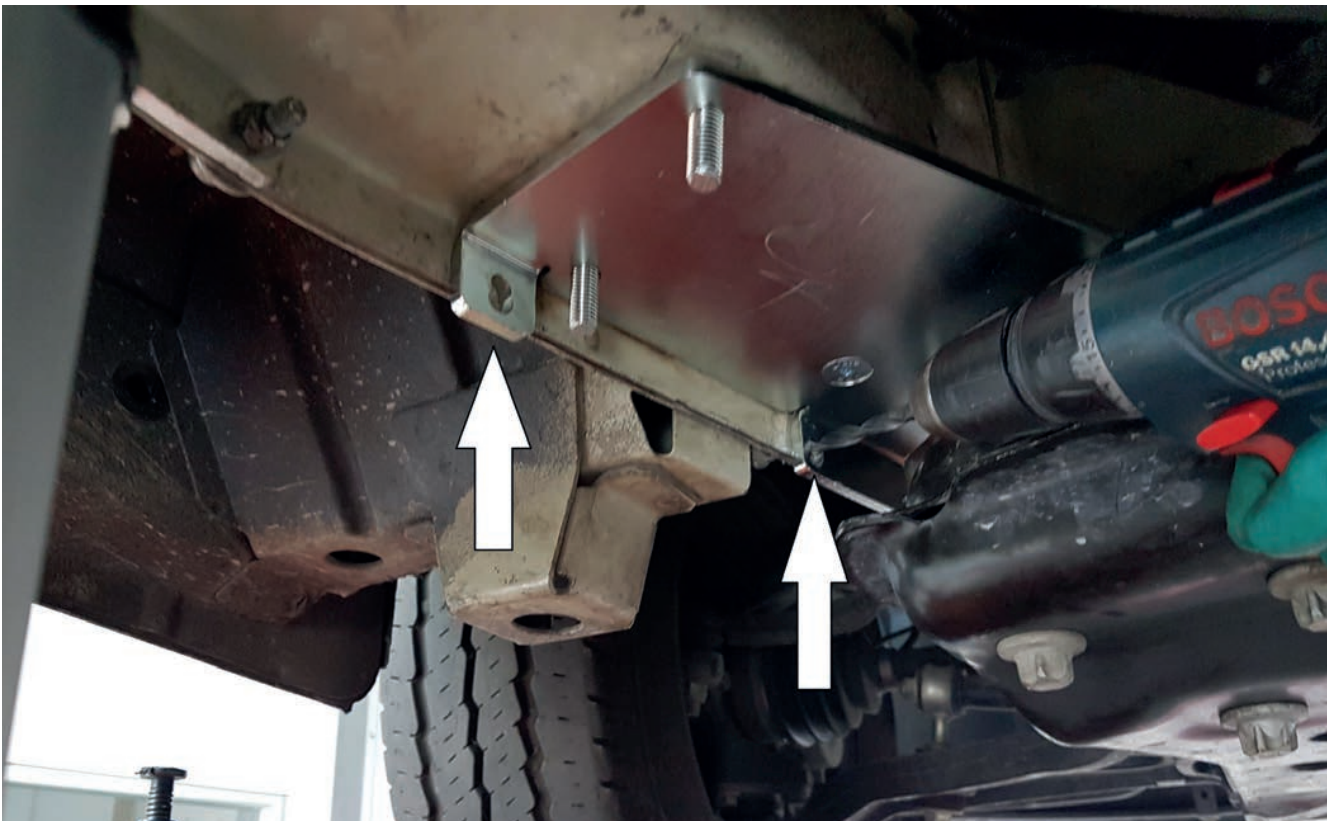
STEP 6:

Drill two 8 mm holes.

STEP 7:

Fix the adapter plate with two M8 bolts on the chassis.

STEP 8:

If necessary, loosen the bolts supporting the tank and move it a few centimeter toward the center of the vehicle.

ATTENTION:

THE MOTOR JACK SHOULD BE FACING THE CENTER OF THE VEHICLE, WHILE BEING ABLE TO ROTATE-TOWARDS THE BACK.

Rear adapter Ducato X250 (in front of the rear axle)

STEP 1:

The rear adapter must be placed before the rear axle, at the place shown in the picture below

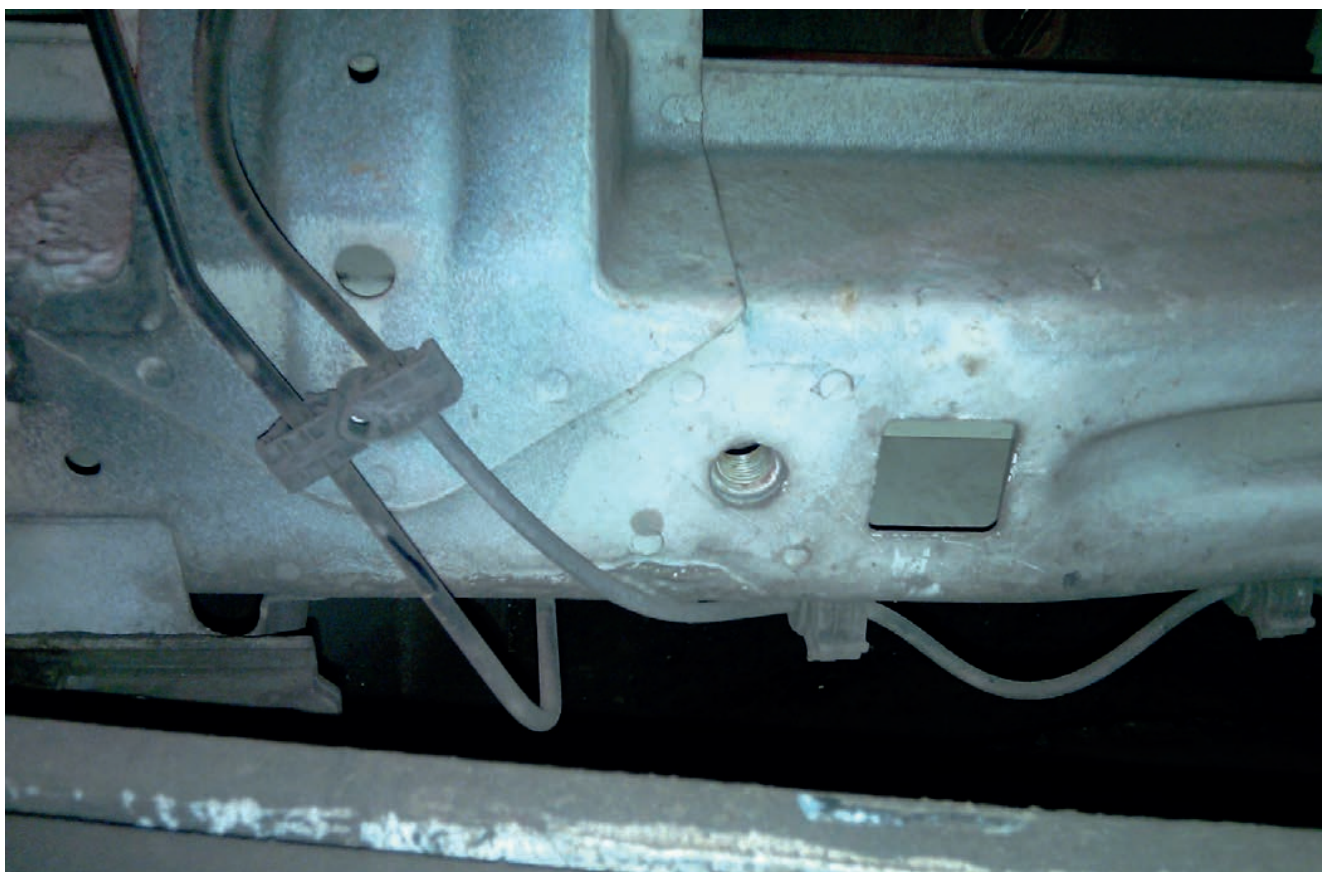

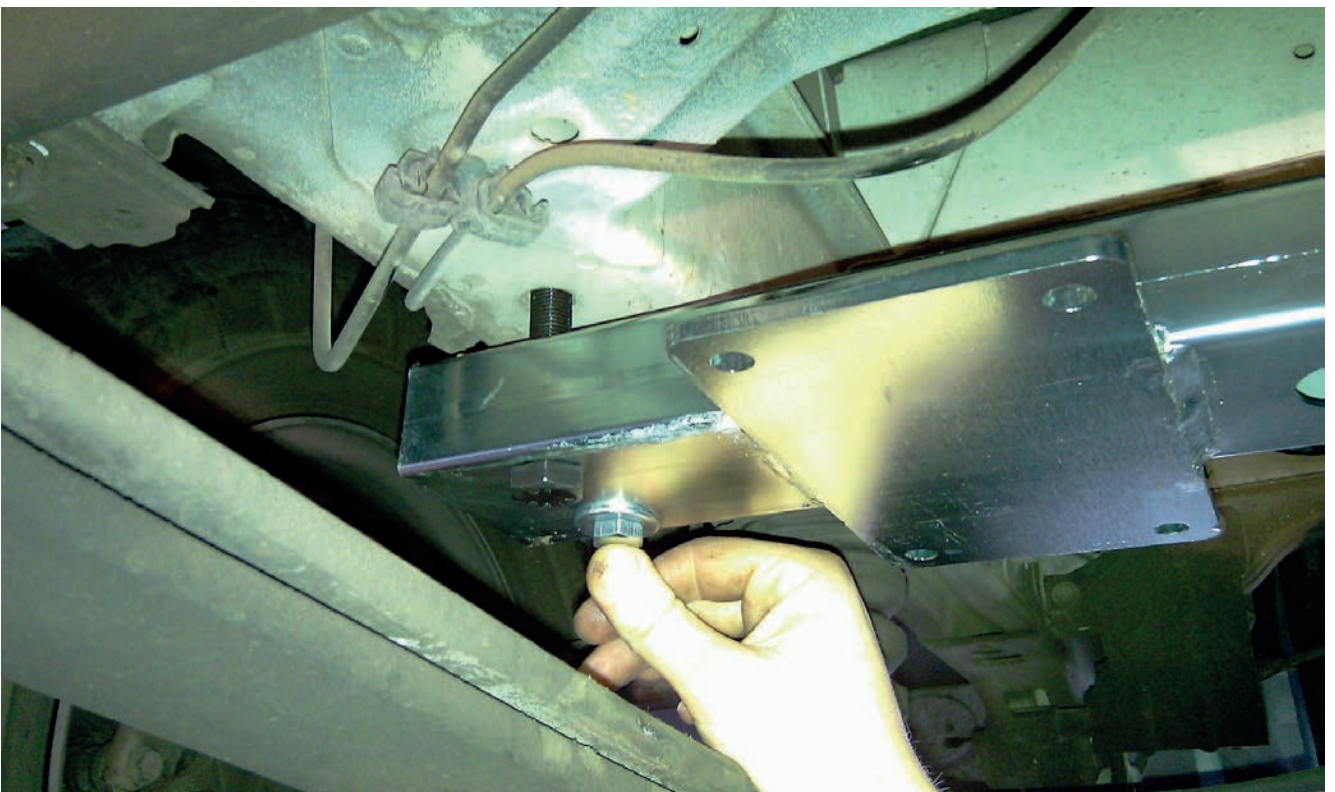
STEP 2:

Insert and position the mounting plate (the plate with only one hole), proceed then with fixing it with 10 x 70 mm and 14 x 70 mm bolts.

ATTENTION:

BOTH REAR MOTOR JACKS SHOULD BE FACING THE CENTER OF THE VEHICLE, WHILE BEING ABLE TO ROTATE TOWARDS THE FRONT.

STEP 3:

The rear adapter must be placed behind the rear axle at the place shown in the photos below, insert the sealing plates (with two holes) and pay attention at the electrical wiring; if necessary move it and insert the adapter into it (see second photo below).





Move the electric wiring to the side, then insert the adapter.



STEP 4:

Fix the adapter using 4 10 x 70 mm bolts, then fix the jacks.

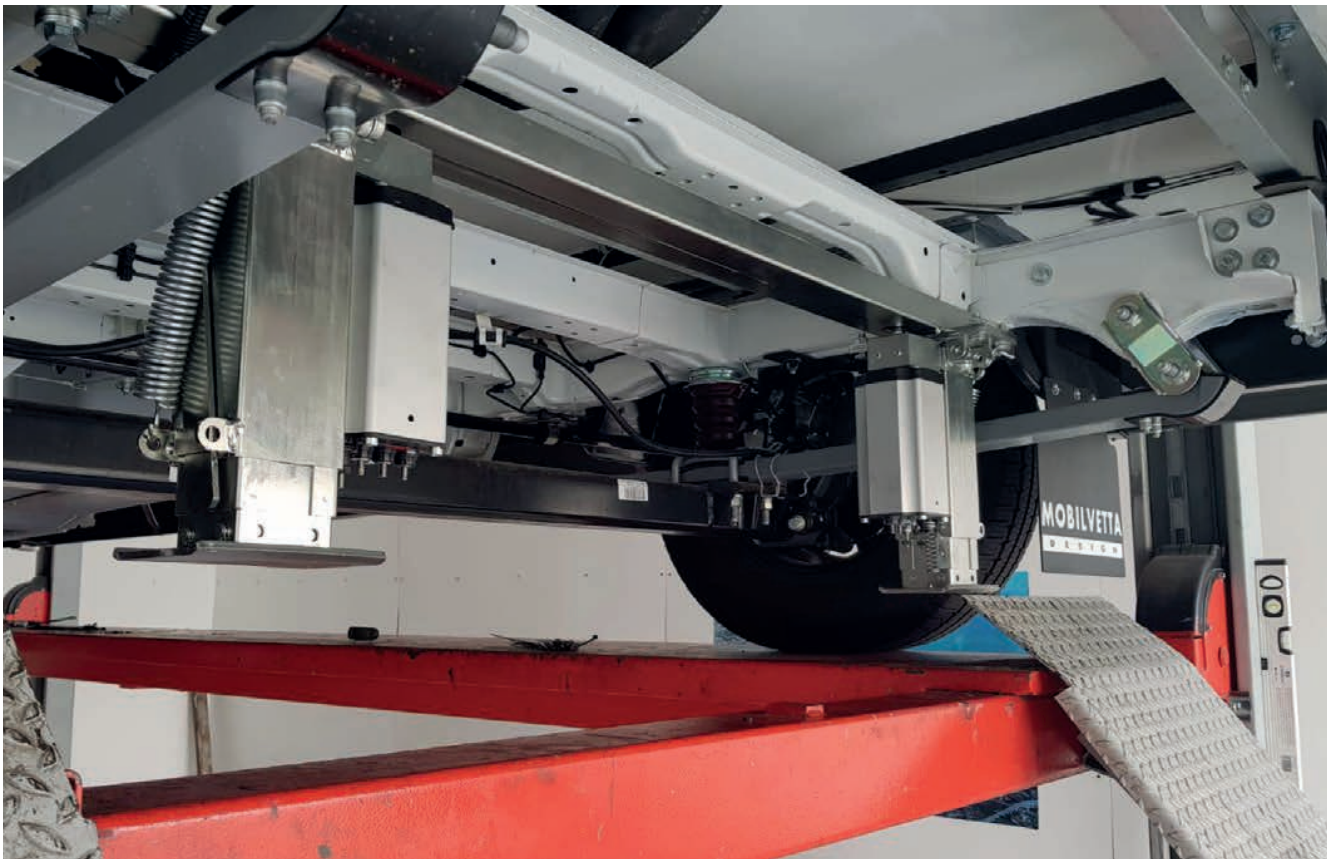
**ATTENTION:**

BOTH REAR MOTOR JACKS SHOULD BE FACING THE CENTER OF THE VEHICLE, WHILE BEING ABLE TO ROTATE TOWARDS THE FRONT OR THE REAR.

CARBEST
INNOVATIONS FOR MOBILE LIFE

Autolift System

ADATTATORE PER DUCATO X290

Art. 465113

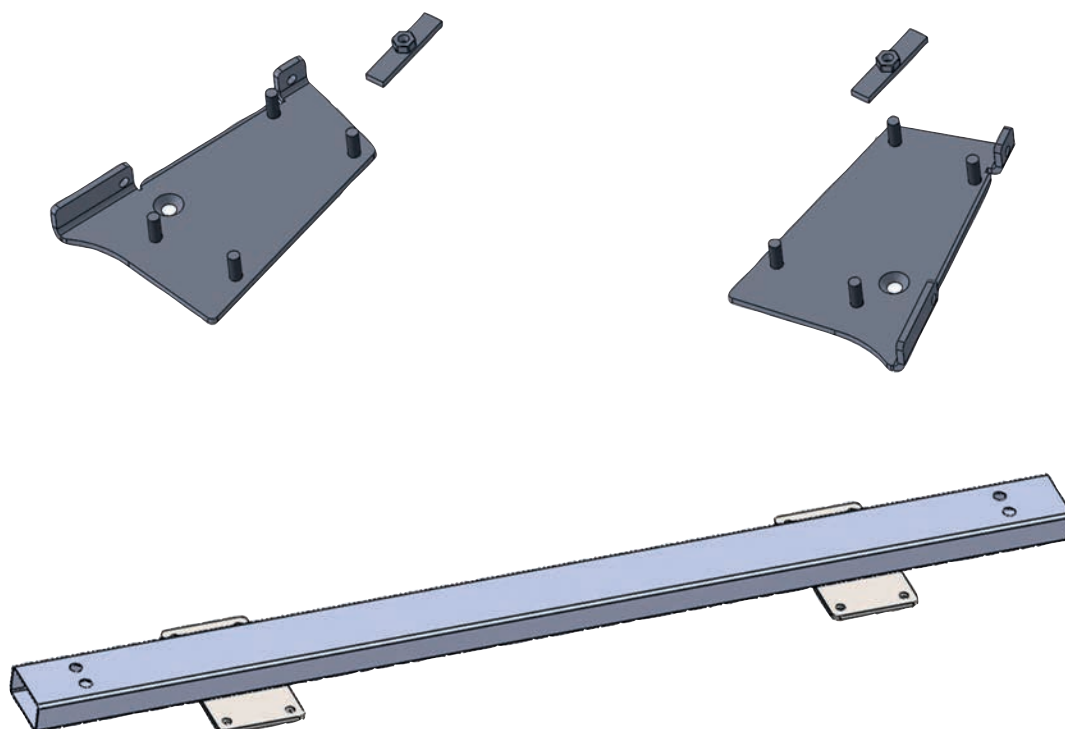

IT- MANUALE D'ISTRUZIONI

ADATTATORE ANTERIORE DUCATO X290

PASSO 1:



Rimuovere il tappo di gomma.

PASSO 2:



Inserire la piastra di montaggio nel foro quadrato.

PASSO 3:

Inserire la piastra di montaggio con il foro della vite concentrico al foro quadrato del telaio.

FASE 4:

Spingere l'adattatore il più avanti possibile.

FASE 5:

Fissare l'adattatore con la piastra di montaggio inserita nel foro.

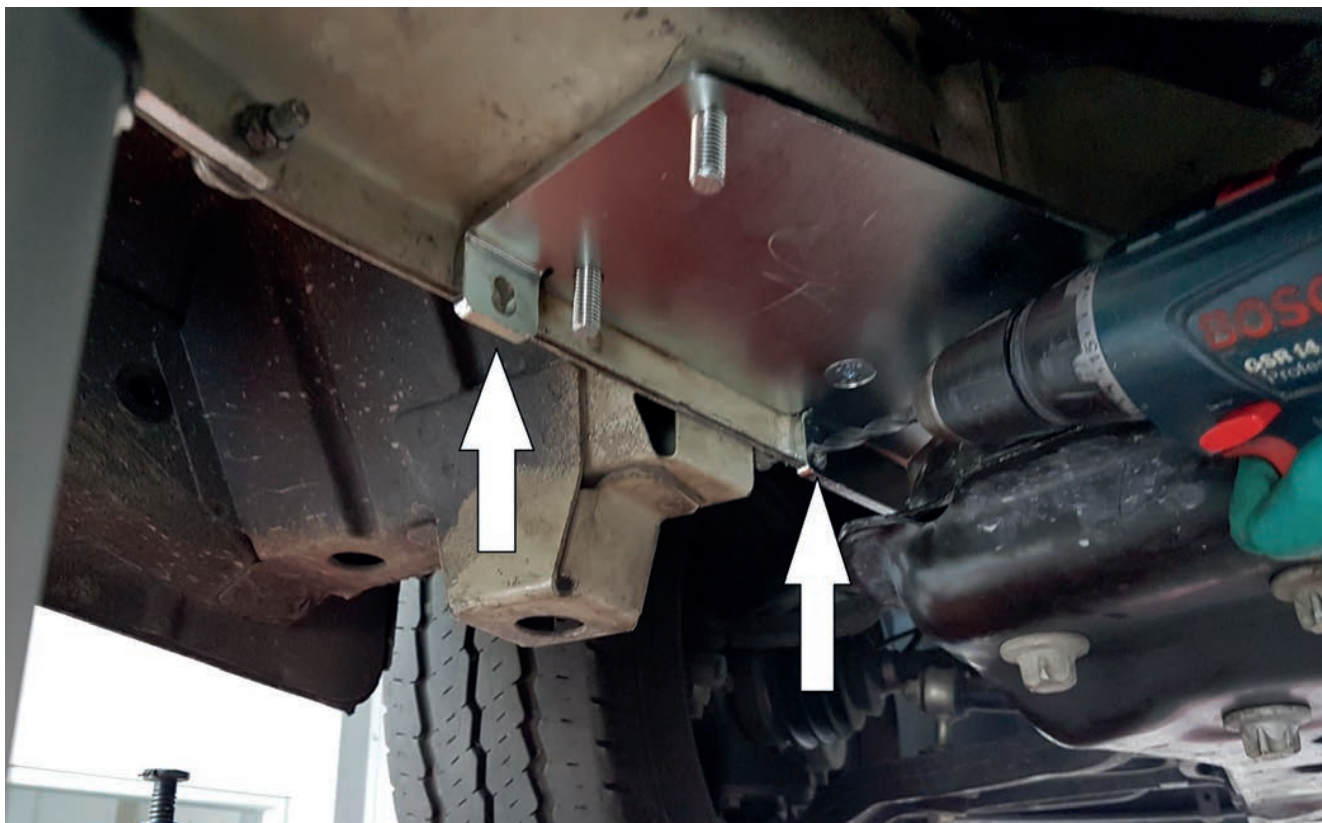
FASE 6:

Praticare due fori da 8 mm.

PASSO 7:

Fissare la piastra di adattamento con due bulloni M8 sul telaio.

FASE 8:

Se necessario, allentare i bulloni di sostegno del serbatoio e spostarlo di qualche centimetro verso il centro del veicolo.

ATTENZIONE: IL MARTINETTO DEL MOTORE DEVE ESSERE RIVOLTO VERSO IL CENTRO DEL VEICOLO, PUR POTENDO RUOTARE VERSO LA PARTE POSTERIORE.

Adattatore posteriore Ducato X250 (davanti all'asse posteriore)

FASE 1:

L'adattatore posteriore deve essere posizionato prima dell'asse posteriore, nel punto indicato nella figura sottostante.

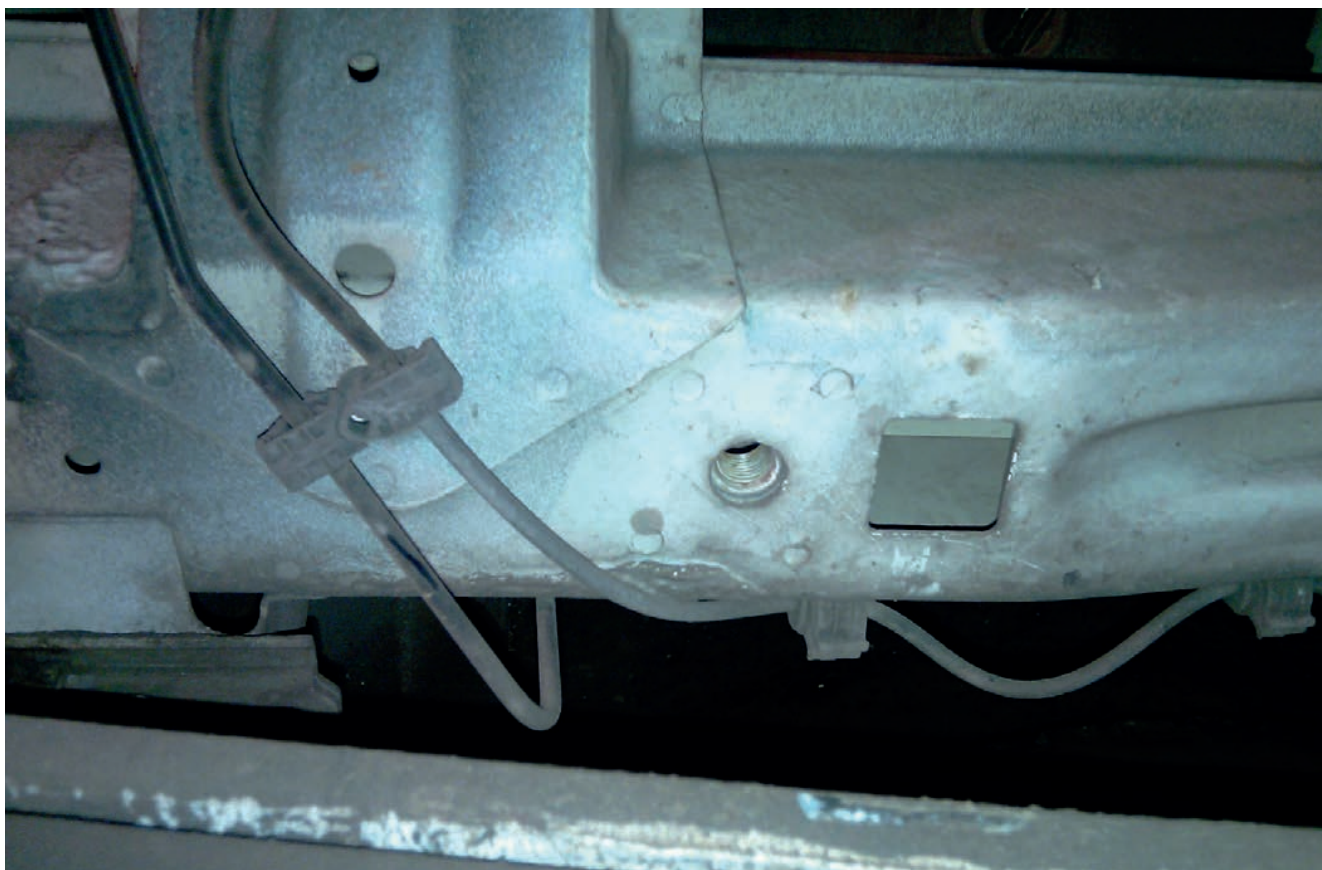

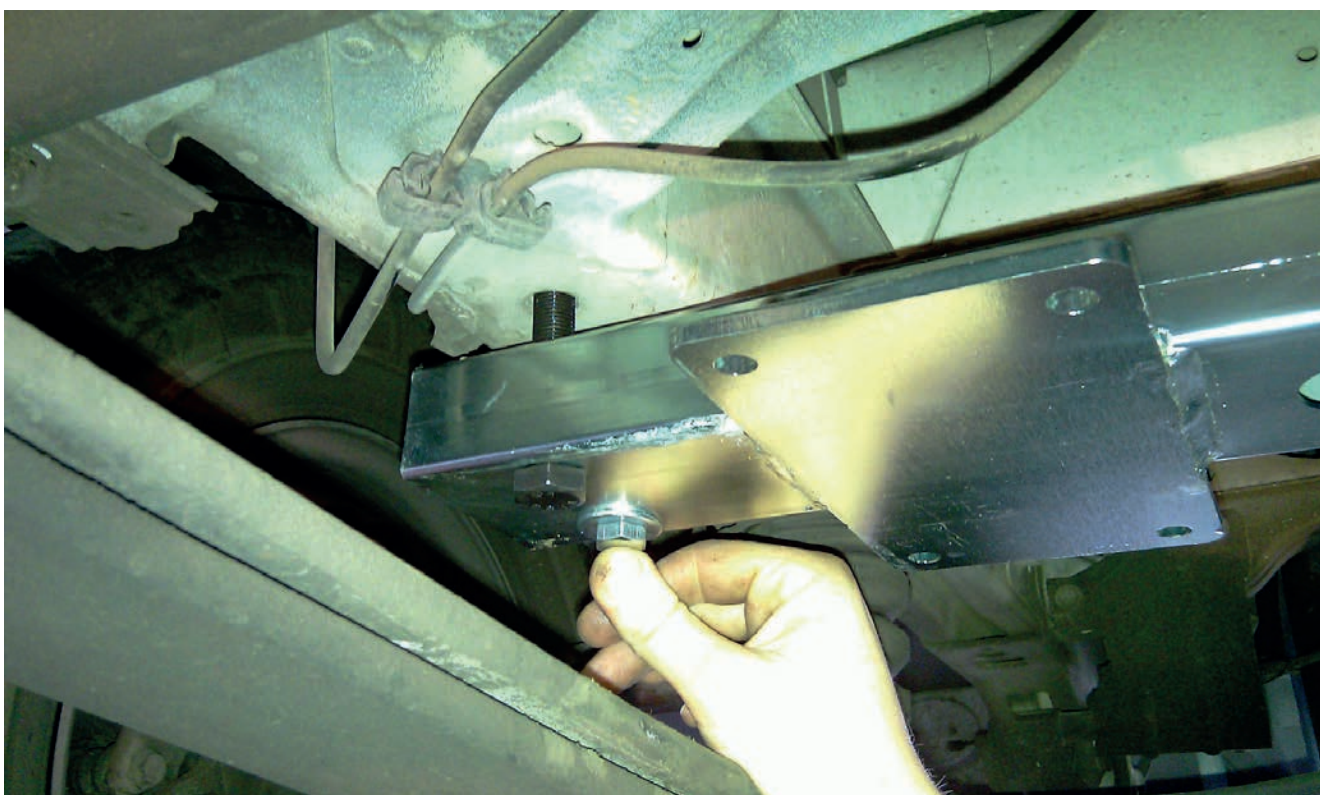
FASE 2:

Inserire e posizionare la piastra di montaggio (quella con un solo foro), quindi procedere al fissaggio con bulloni 10 x 70 mm e 14 x 70 mm.

ATTENZIONE: ENTRAMBI I MARTINETTI DEL MOTORE POSTERIORE DEVONO ESSERE RIVOLTI VERSO IL CENTRO DEL VEICOLO, PUR POTENDO RUOTARE VERSO LA PARTE ANTERIORE.

FASE 3:

L'adattatore posteriore deve essere posizionato dietro l'assale posteriore nel punto indicato nelle foto sottostanti, inserire le piastre di tenuta (con due fori) e prestare attenzione al cablaggio elettrico; se necessario, spostarlo e inserirvi l'adattatore (vedere la seconda foto sottostante).





Spostare il cablaggio elettrico lateralmente, quindi inserire l'adattatore.



PASSO 4:

Fissare l'adattatore con 4 bulloni 10 x 70 mm, quindi fissare i martinetti.

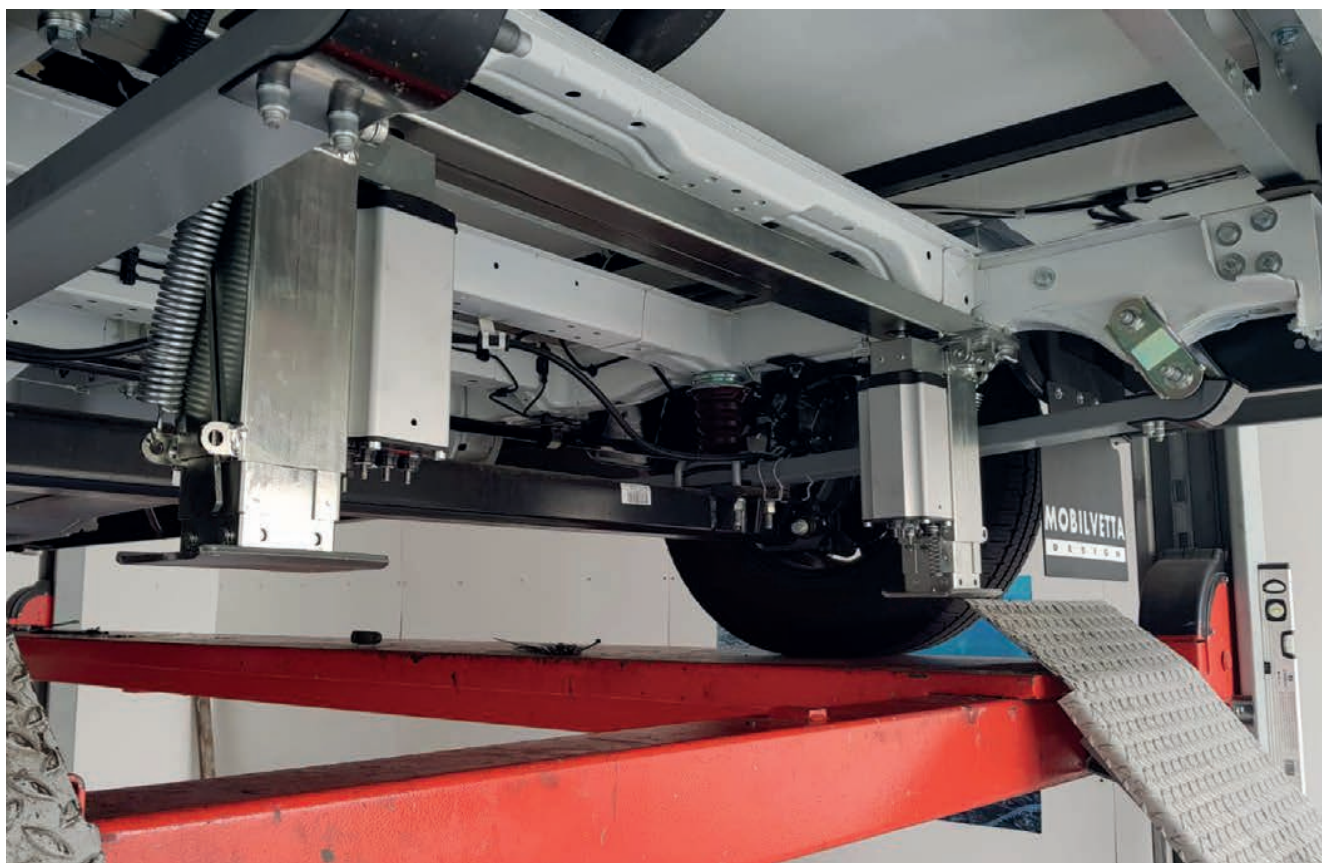

ATTENZIONE: ENTRAMBI I MARTINETTI DEL MOTORE POSTERIORE DEVONO ESSERE RIVOLTI VERSO IL CENTRO DEL VEICOLO, PUR POTENDO RUOTARE VERSO LA PARTE ANTERIORE O POSTERIORE.

CARBEST
INNOVATIONS FOR MOBILE LIFE

Autolift System

ADAPTER PARA DUCATO X290

Art. 465113

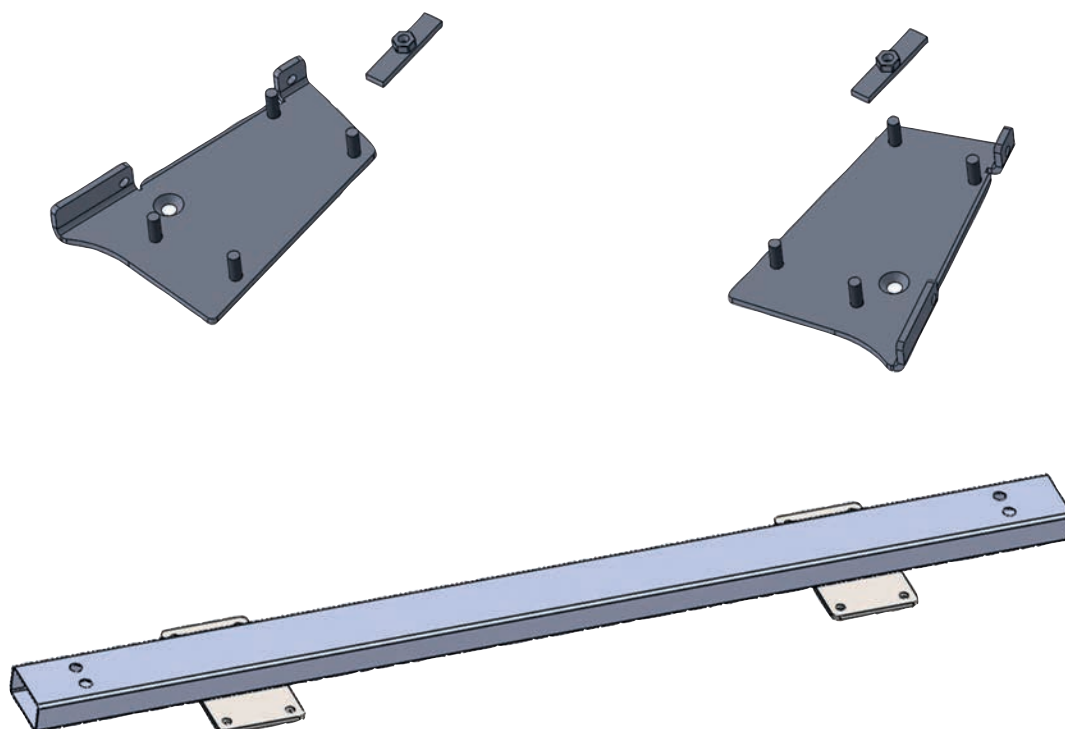

ES – MANUAL DEL USUARIO.

ADAPTADOR FRONTAL DUCATO X290

PASO 1:



Retirar el tapón de goma.

PASO 2:



Inserte la placa de montaje en el orificio cuadrado.

PASO 3:

Inserte la placa de montaje con el orificio del tornillo concéntrico al orificio cuadrado del chasis.

PASO 4:

Empuje el adaptador hacia delante tanto como sea posible.

PASO 5:

Fije el adaptador con la placa de montaje que ha introducido en el orificio.

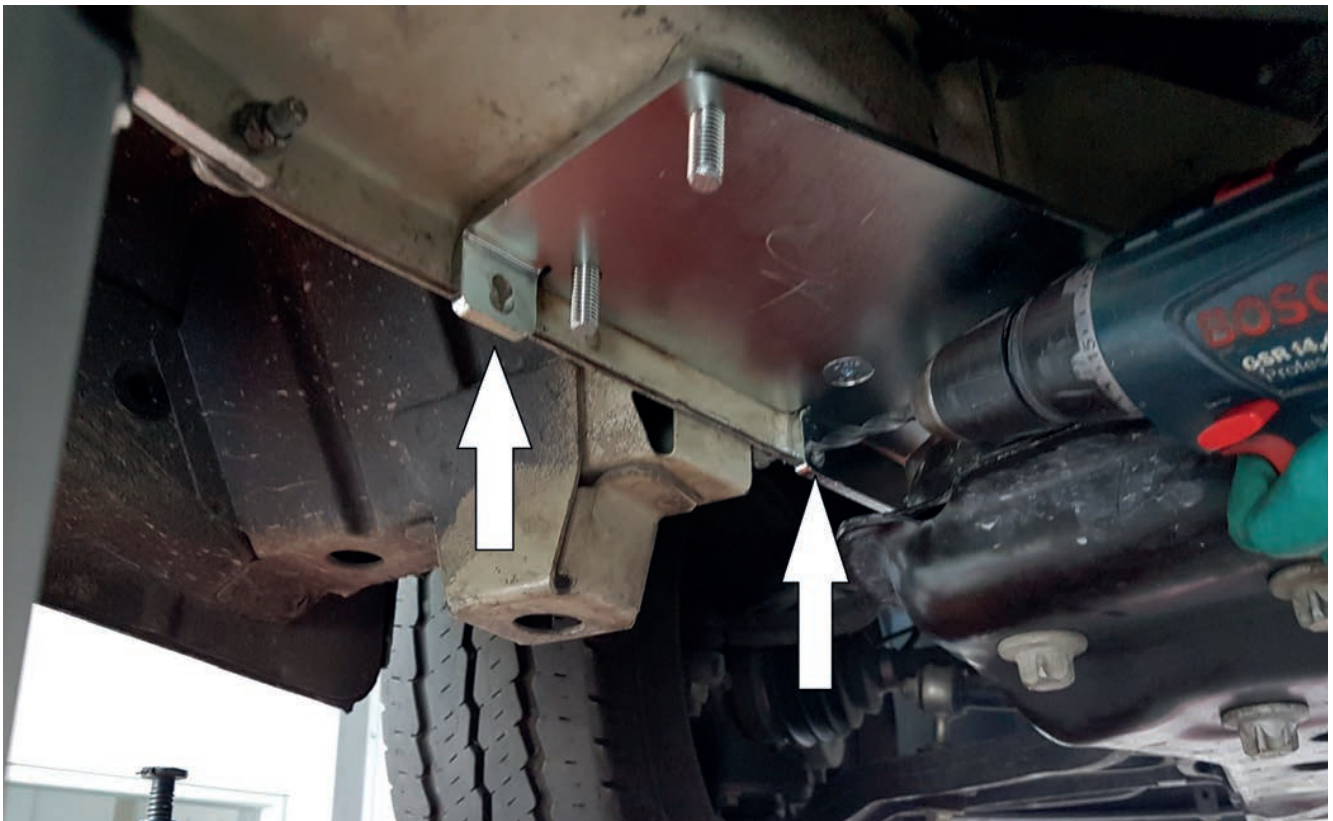
PASO 6:

Taladre dos orificios de 8 mm.

PASO 7:

Fije la placa adaptadora con dos tornillos M8 en el chasis.

PASO 8:

Si es necesario, afloje los tornillos que sujetan el depósito y desplácelo unos centímetros hacia el centro del vehículo.

**ATENCIÓN: EL GATO DEL MOTOR DEBE ESTAR ORIENTADO HACIA EL CENTRO DEL VEHÍCULO, MIEN-
TRAS SE PUEDE ROTAR HACIA ATRÁS.**

Adaptador trasero Ducato X250 (delante del eje trasero)

PASO 1:

El adaptador trasero debe colocarse antes del eje trasero, en el lugar que se muestra en la siguiente imagen.

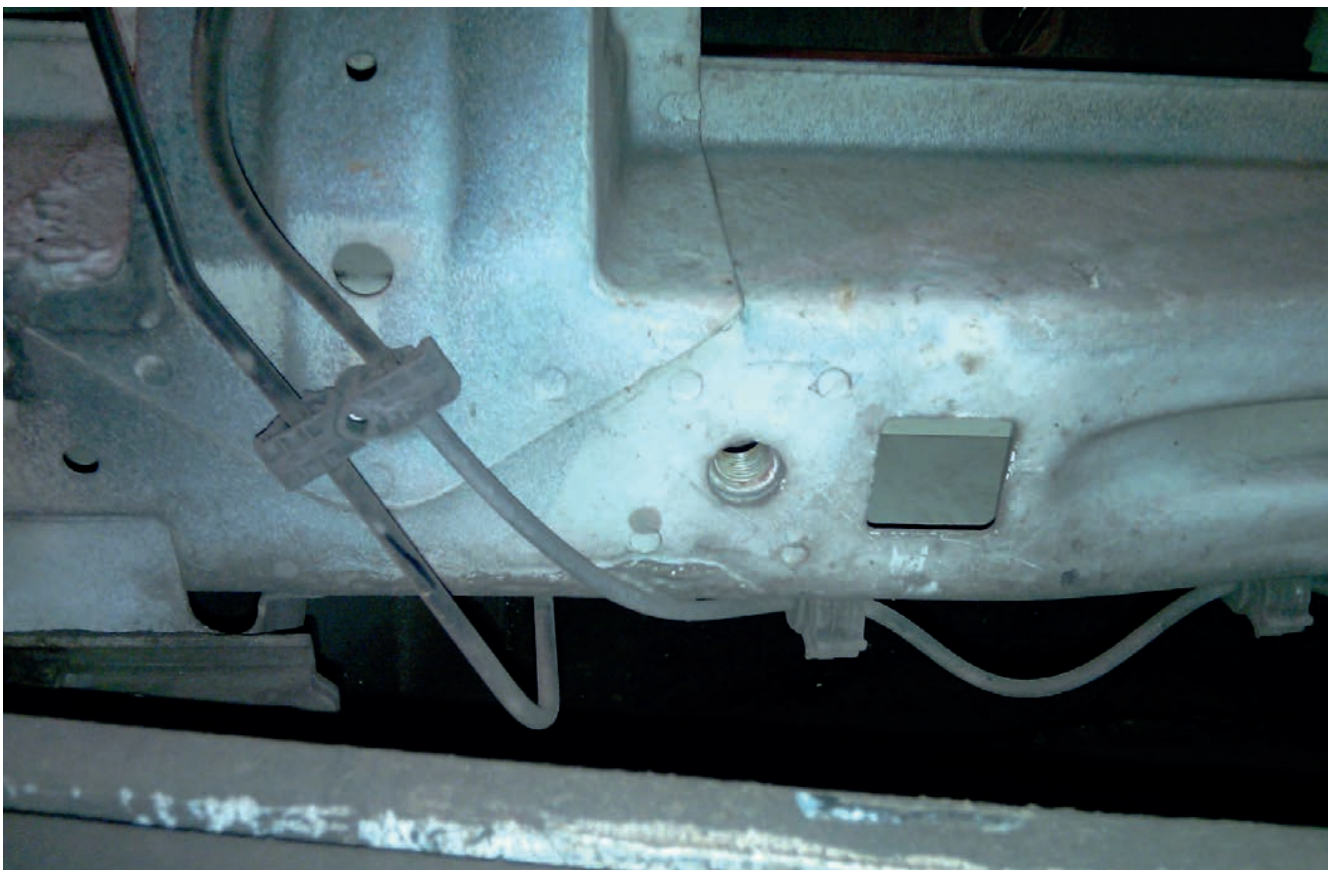

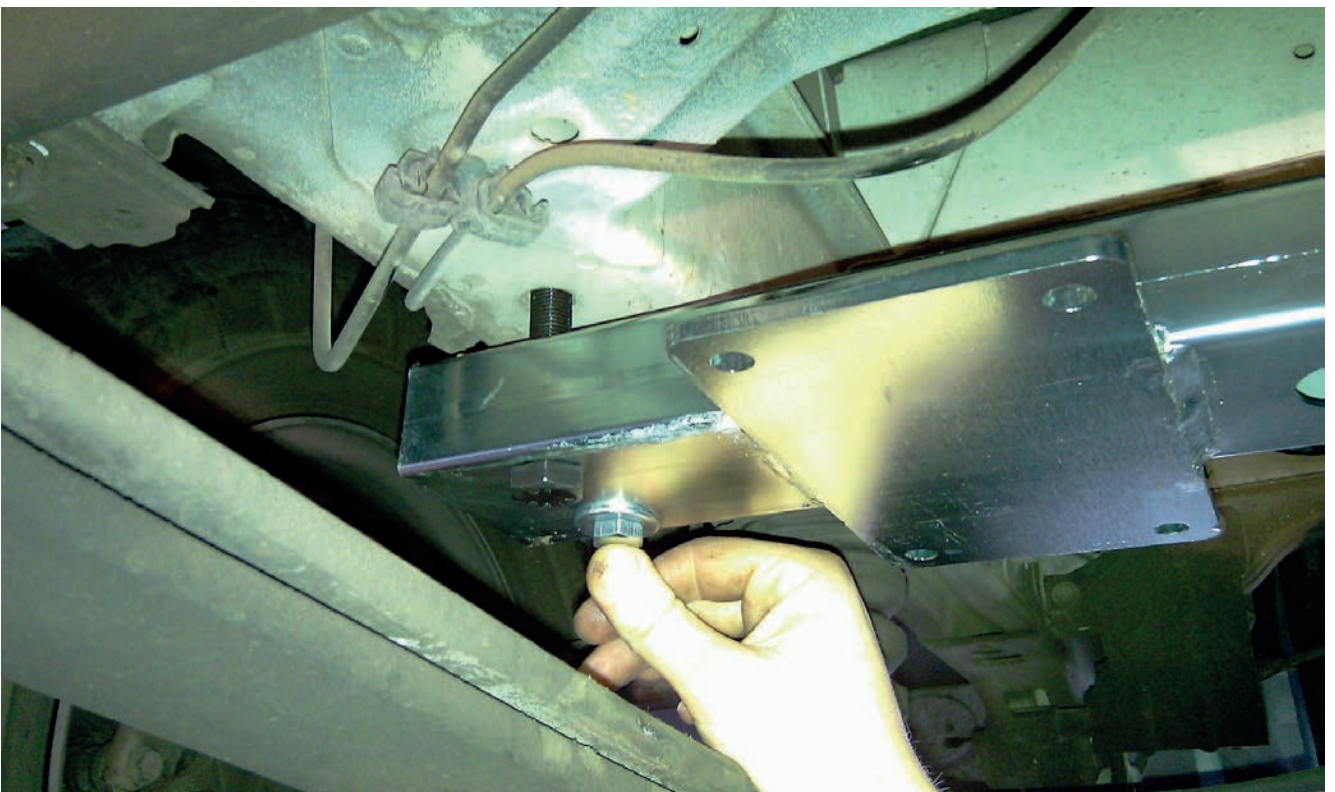
PASO 2:

Inserte y coloque la placa de montaje (la placa con un solo orificio), proceda entonces a fijarla con tornillos de 10 x 70 mm y 14 x 70 mm.

ATENCIÓN: LOS DOS GATOS DEL MOTOR TRASERO DEBEN ESTAR ORIENTADOS HACIA EL CENTRO DEL VEHÍCULO, PUDIENDO GIRAR HACIA DELANTE.

PASO 3:

El adaptador trasero debe ser colocado detrás del eje trasero en el lugar mostrado en las fotos de abajo, inserte las placas de sellado (con dos agujeros) y preste atención al cableado eléctrico; si es necesario muévelo e inserte el adaptador en él (vea la segunda foto de abajo).





Mueva el cableado eléctrico hacia un lado e inserte el adaptador.



PASO 4:

Fije el adaptador con 4 tornillos de 10 x 70 mm, luego fije los gatos.

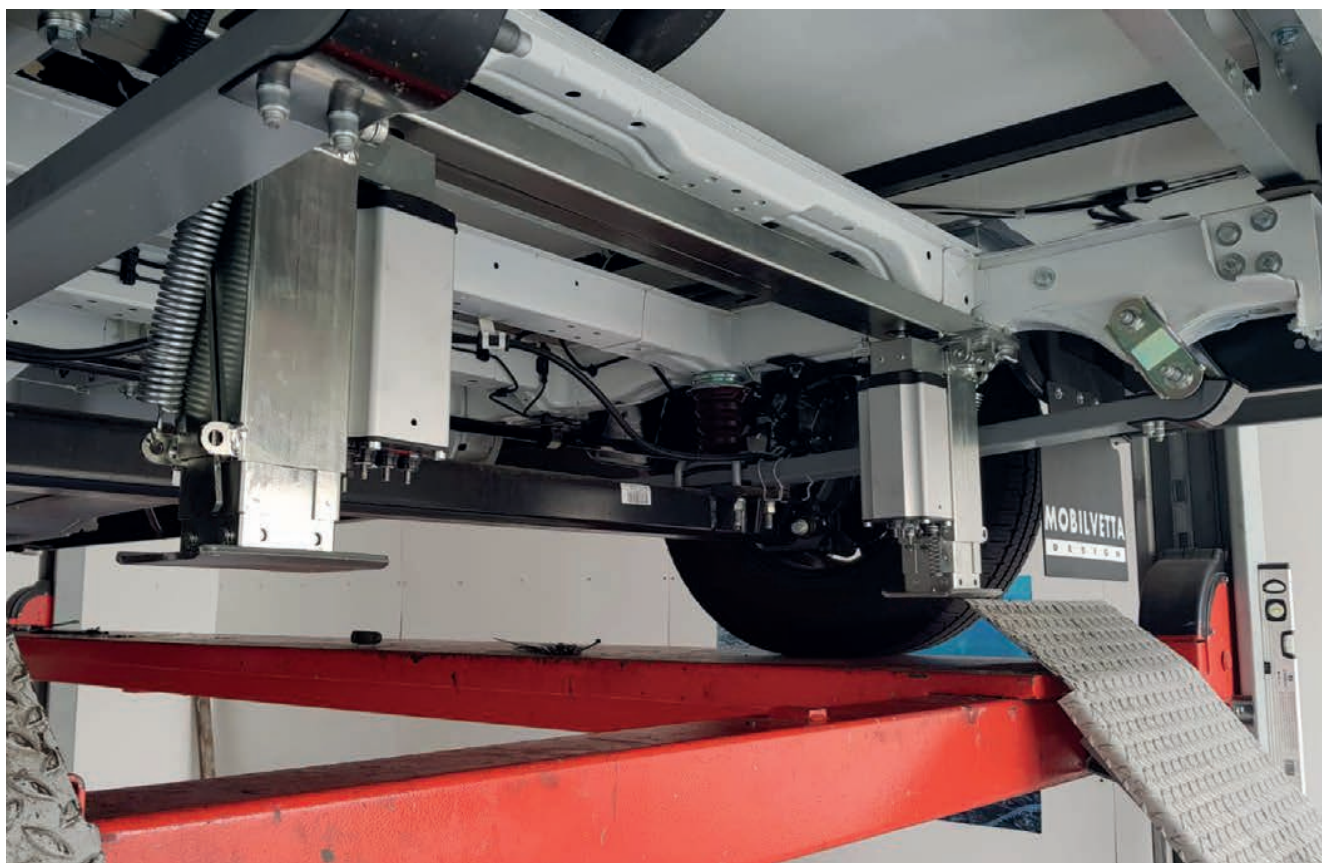

ATENCIÓN: LOS DOS GATOS DEL MOTOR TRASERO DEBEN ESTAR ORIENTADOS HACIA EL CENTRO DEL VEHÍCULO, PUDIENDO GIRAR HACIA DELANTE O HACIA ATRÁS.

CARBEST
INNOVATIONS FOR MOBILE LIFE

Autolift System

ADAPTER VOOR DUCATO X290

Art. 465113

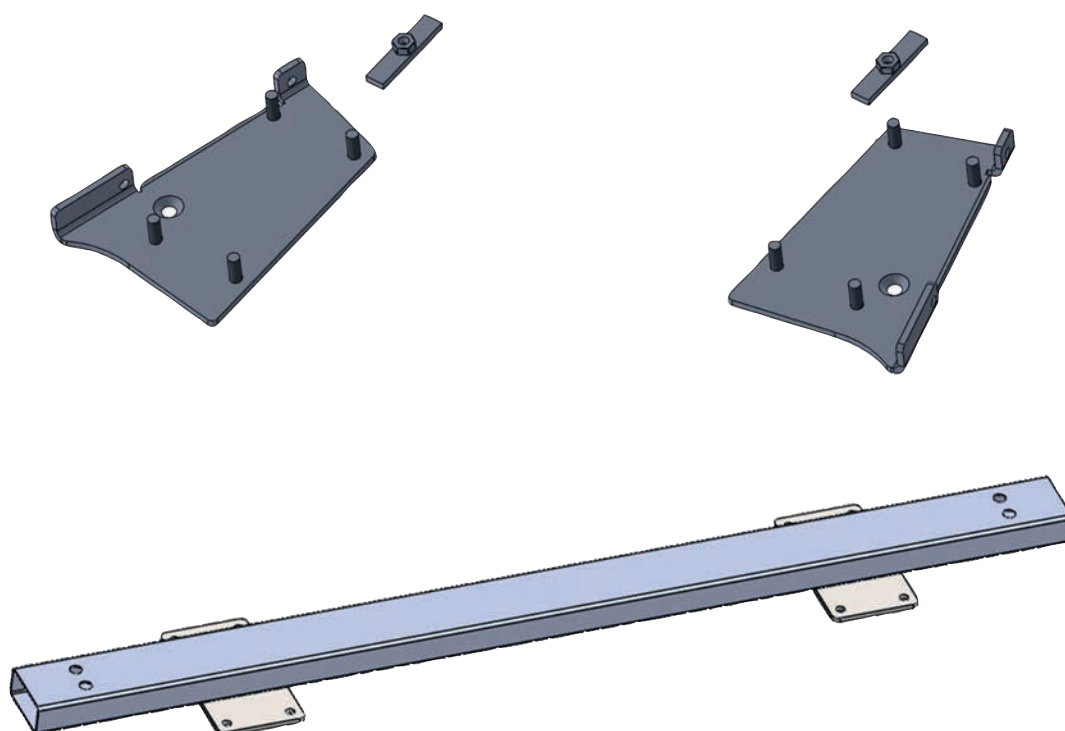

NL – INSTRUCTIEHANDLEIDING

VOORSTE ADAPTER DUCATO X290

STAP 1:



Verwijder de rubberen stop.

STAP 2:



Plaats de montageplaat in het vierkante gat.

STAP 3:

Plaats de montageplaat met het schroefgat concentrisch op het vierkante gat in het chassis.

STAP 4:

Duw de adapter zo ver mogelijk naar voren.

STAP 5:

Zet de adapter vast met de montageplaat die u in het gat hebt gestoken.

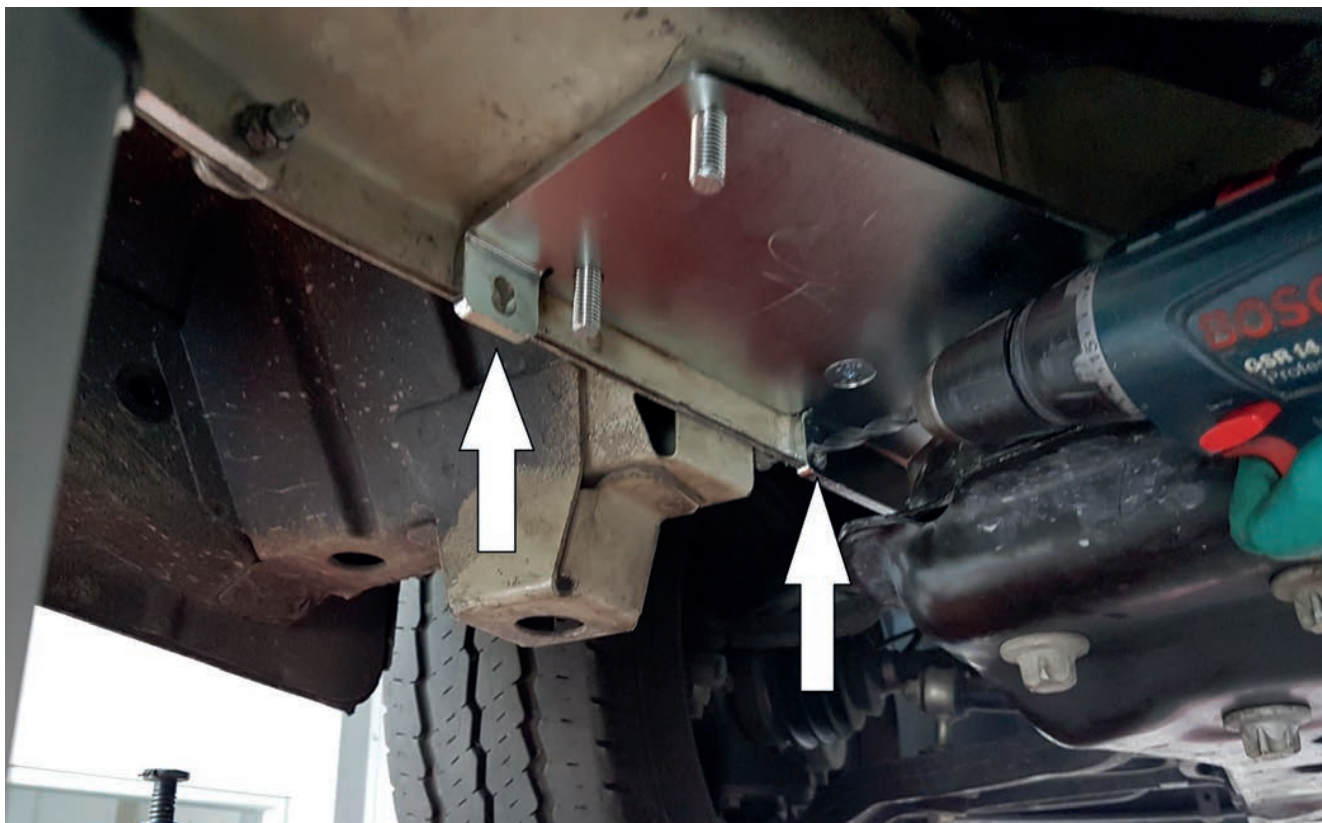
STAP 6:

Boor twee gaten van 8 mm.

STAP 7:

Bevestig de adapterplaat met twee M8-bouten op het chassis.

STAP 8:

Draai indien nodig de bouten die de tank ondersteunen los en verplaats deze enkele centimeters naar het midden van het voertuig.

OPGELET: DE MOTORSTEUN MOET NAAR HET MIDDEN VAN HET VOERTUIG GERICHT ZIJN, TERWIJL HIJ NAAR ACHTEREN KAN DRAAIEN.

Achterste adapter Ducato X250 (voor de achteras)

STAP 1:

De achterste adapter moet vóór de achteras worden geplaatst, op de plaats die op de onderstaande afbeelding is aangegeven.

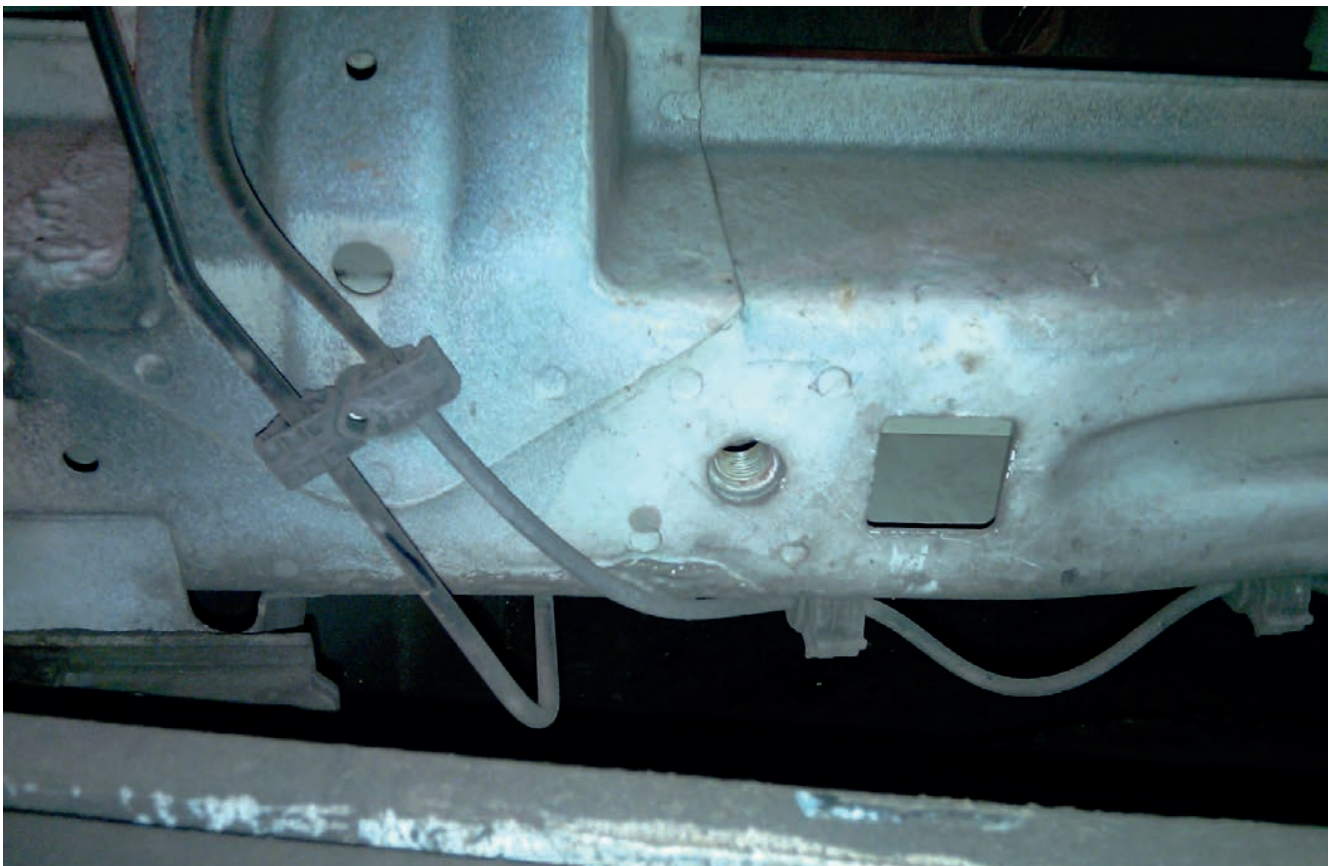

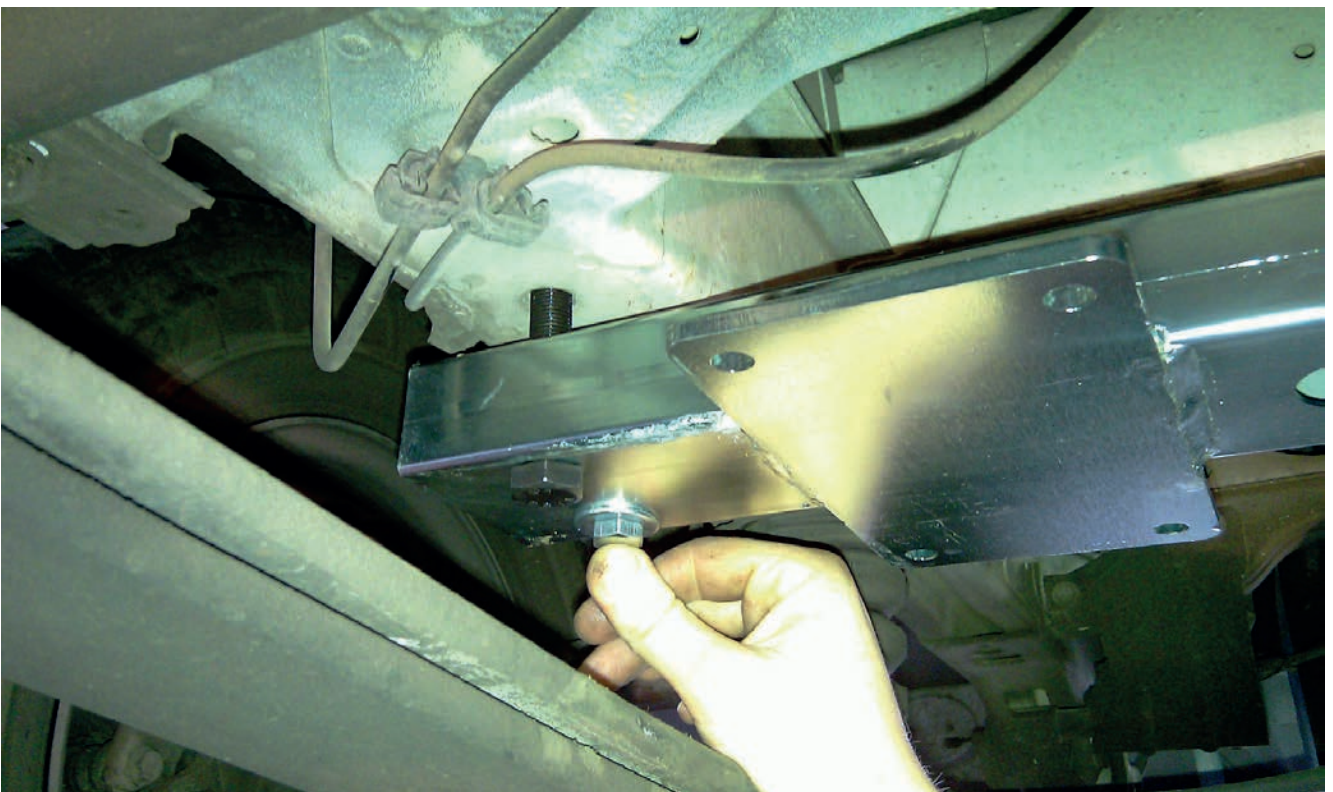
STAP 2:

Plaats en positioneer de bevestigingsplaat (de plaat met slechts één gat), ga vervolgens over tot de bevestiging met bouten van 10 x 70 mm en 14 x 70 mm.

LET OP: BEIDE ACHTERSTE MOTORSTEUNEN MOETEN NAAR HET MIDDEN VAN HET VOERTUIG GERICHT ZIJN, TERWIJL ZE NAAR VOREN KUNNEN DRAAIEN.

STAP 3:

De achterste adapter moet achter de achteras worden geplaatst op de plaats die op de onderstaande foto's is aangegeven, plaats de afdichtingsplaten (met twee gaten) en let op de elektrische bedrading; verplaats deze indien nodig en plaats de adapter erin (zie tweede foto hieronder).





Verplaats de elektrische bedrading naar de zijkant en plaats dan de adapter.



STAP 4:

Zet de adapter vast met 4 bouten van 10 x 70 mm en zet vervolgens de poten vast.

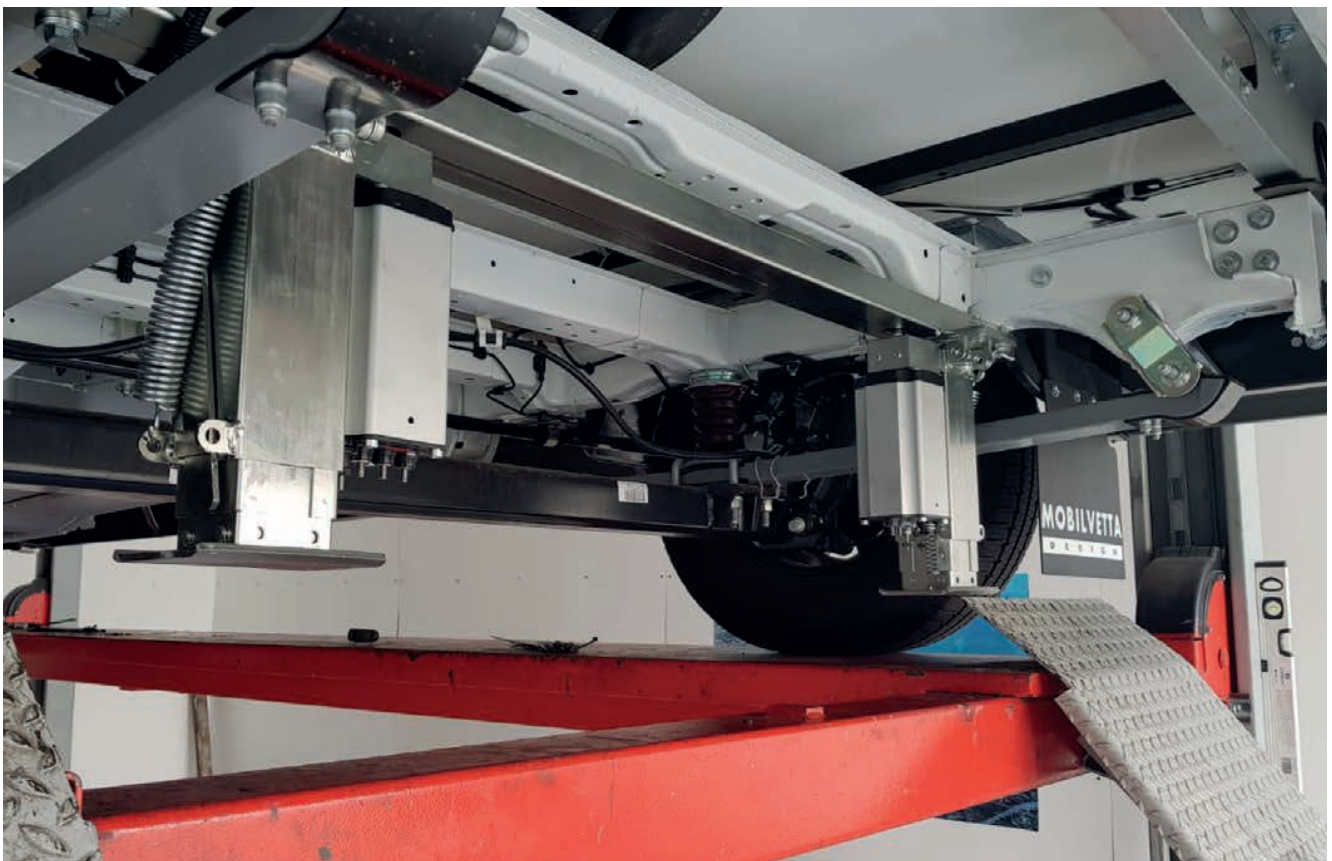

LET OP: BEIDE ACHTERSTE MOTORSTEUNEN MOETEN NAAR HET MIDDEN VAN HET VOERTUIG GERICHT ZIJN, TERWIJL ZE NAAR VOREN OF NAAR ACHTEREN KUNNEN DRAAIEN.

CARBEST
INNOVATIONS FOR MOBILE LIFE

Autolift System

ADAPTATEUR POUR DUCATO X290

Art. 465113

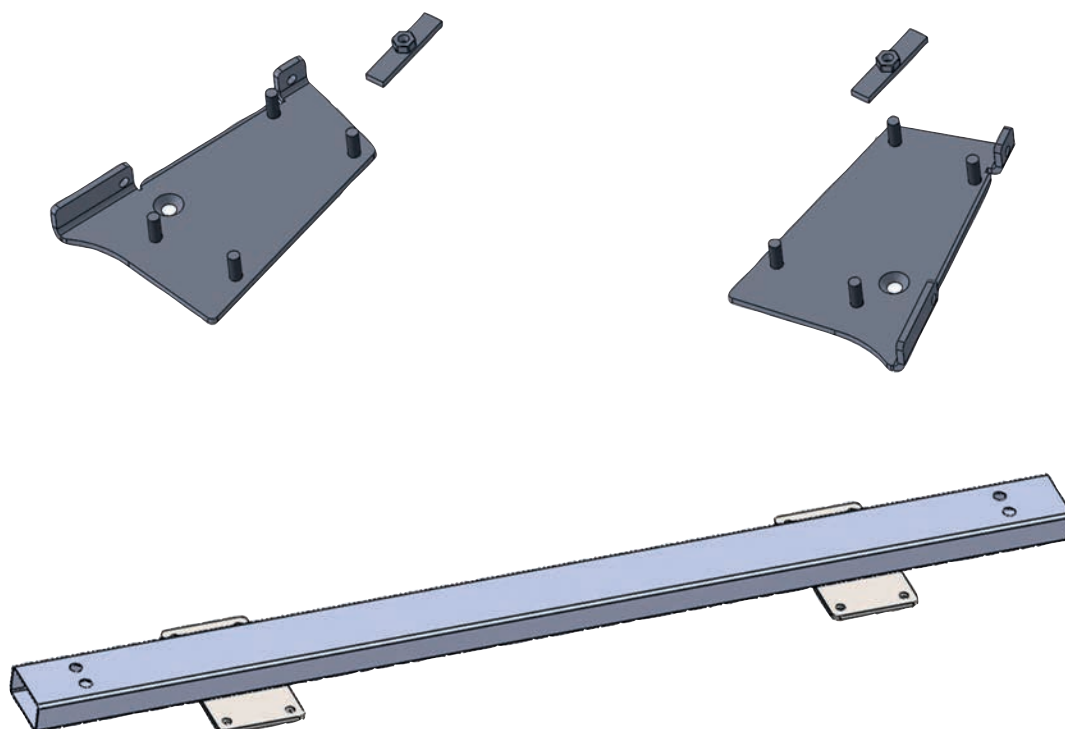

FR – MANUEL D'UTILISATION.

ADAPTATEUR AVANT DUCATO X290

ÉTAPE 1 :



Retirez le bouchon en caoutchouc.

ÉTAPE 2 :



Insérez la plaque de montage dans le trou carré.

ÉTAPE 3 :

Insérez la plaque de montage avec le trou de vis concentrique au trou carré du châssis.

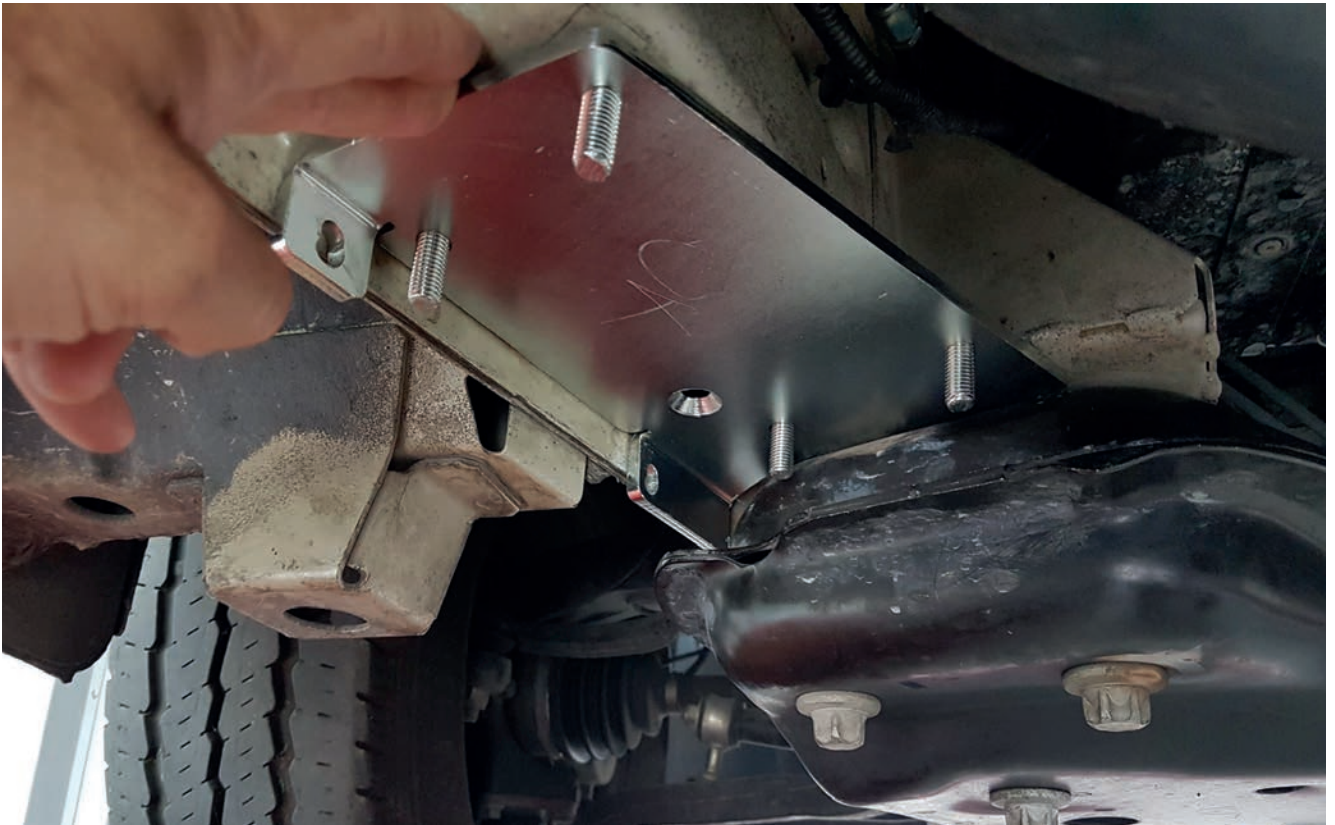
ÉTAPE 4 :

Poussez l'adaptateur aussi loin que possible vers l'avant.

ÉTAPE 5 :

Fixez l'adaptateur avec la plaque de montage que vous avez insérée dans le trou.

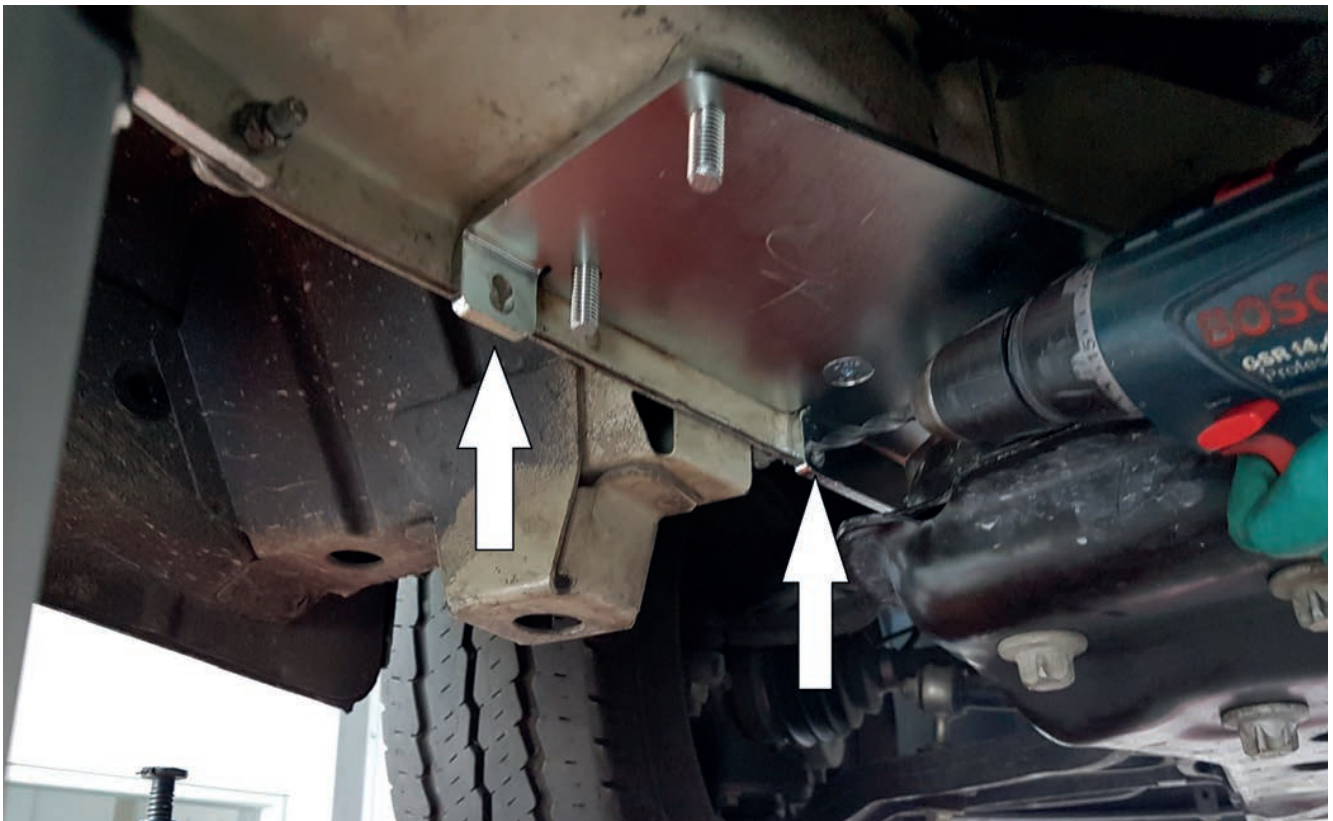
ÉTAPE 6 :

Percez deux trous de 8 mm.

ÉTAPE 7 :

Fixez la plaque de l'adaptateur avec deux boulons M8 sur le châssis.

ÉTAPE 8 :

Si nécessaire, desserrez les boulons qui soutiennent le réservoir et déplacez-le de quelques centimètres vers le centre du véhicule.

ATTENTION : LE CRIC MOTEUR DOIT ÊTRE ORIENTÉ VERS LE CENTRE DU VÉHICULE, TOUT EN POUVANT TOURNER VERS L'ARRIÈRE.

Adaptateur arrière Ducato X250 (devant l'essieu arrière)

ÉTAPE 1 :

L'adaptateur arrière doit être placé devant l'essieu arrière, à l'endroit indiqué sur la photo ci-dessous.

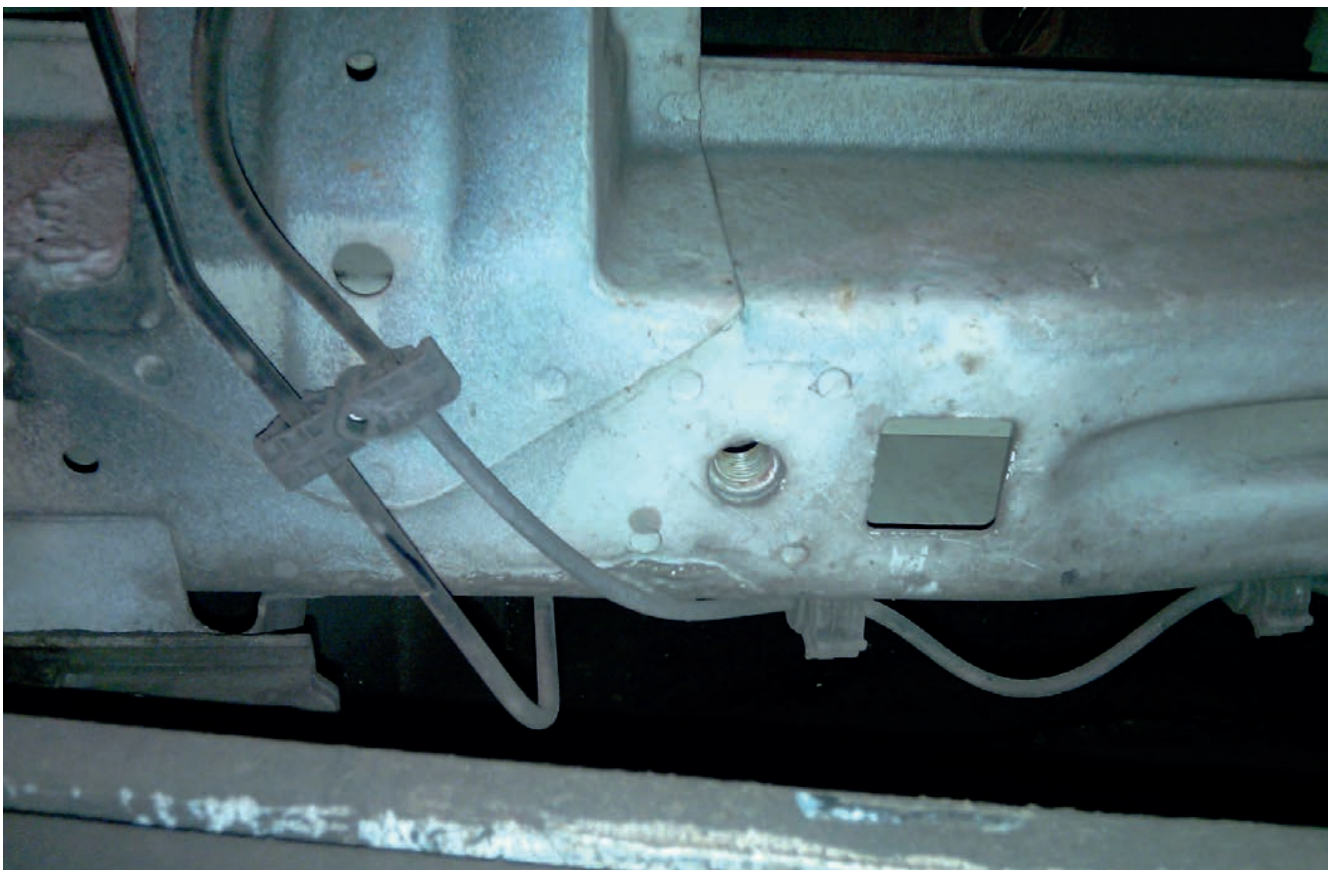

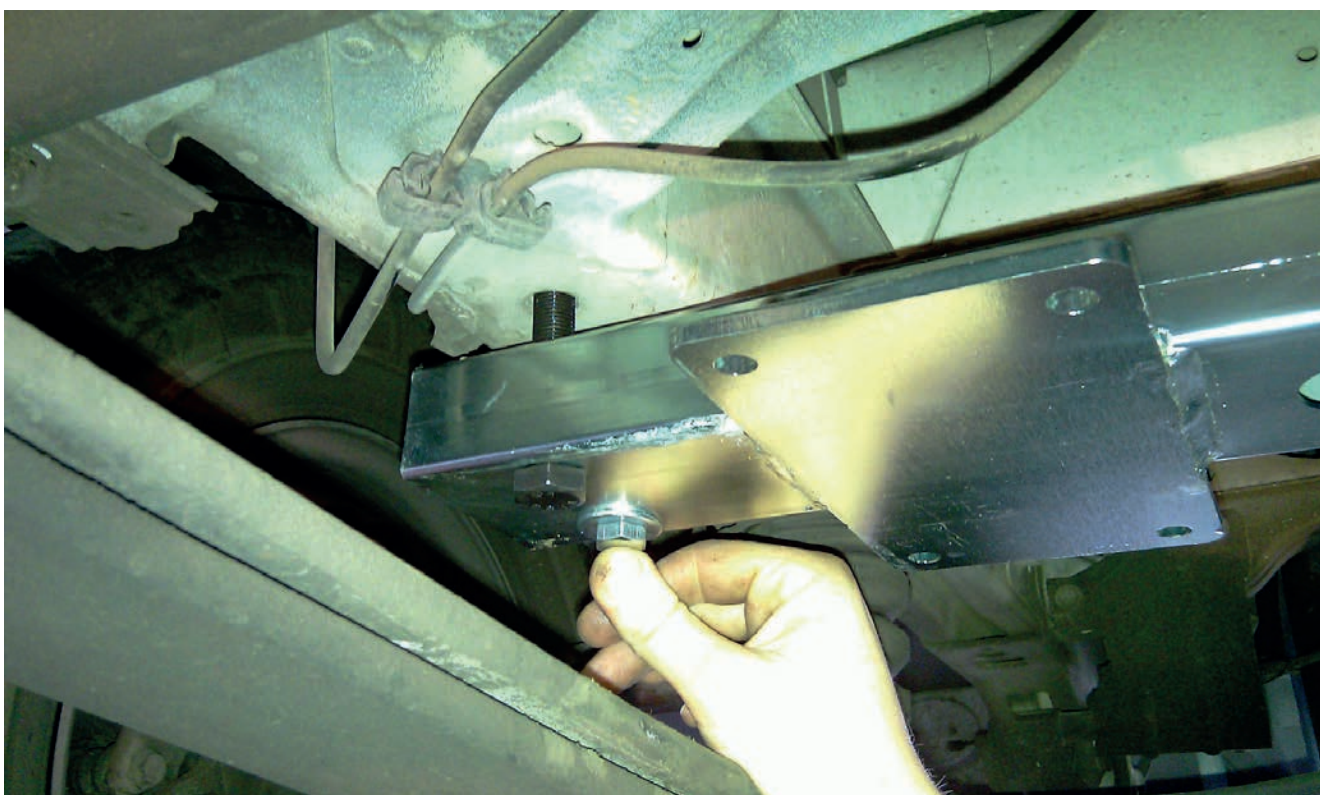
ETAPE 2 :

Insérez et positionnez la plaque de montage (la plaque avec un seul trou), procédez ensuite à sa fixation avec des boulons de 10 x 70 mm et 14 x 70 mm.

ATTENTION : LES DEUX VÉRINS DU MOTEUR ARRIÈRE DOIVENT ÊTRE ORIENTÉS VERS LE CENTRE DU VÉHICULE, TOUT EN POUVANT PIVOTER VERS L'AVANT.

ÉTAPE 3 :

L'adaptateur arrière doit être placé derrière l'essieu arrière à l'endroit indiqué sur les photos ci-dessous, insérez les plaques d'étanchéité (avec deux trous) et faites attention au câblage électrique ; si nécessaire, déplacez-le et insérez l'adaptateur dans celui-ci (voir la deuxième photo ci-dessous).





Déplacez le câblage électrique sur le côté, puis insérez l'adaptateur.



ÉTAPE 4 :

Fixez l'adaptateur à l'aide de 4 boulons de 10 x 70 mm, puis fixez les vérins.

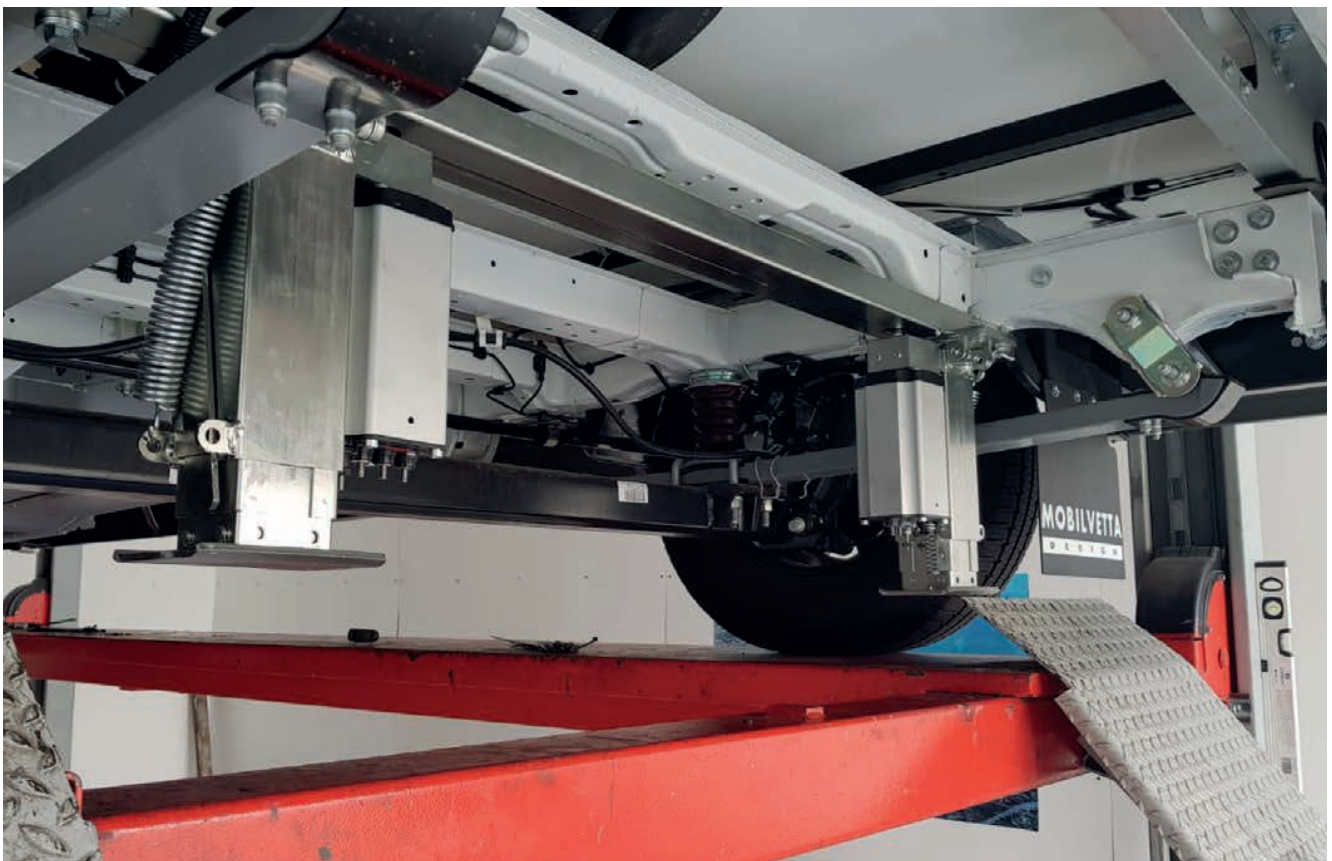

ATTENTION : LES DEUX VÉRINS DU MOTEUR ARRIÈRE DOIVENT ÊTRE ORIENTÉS VERS LE CENTRE DU VÉHICULE, TOUT EN POUVANT PIVOTER VERS L'AVANT OU L'ARRIÈRE.

CARBEST
INNOVATIONS FOR MOBILE LIFE

Autolift System

SOVITIN DUCATO X290:LLE

Art. 465113

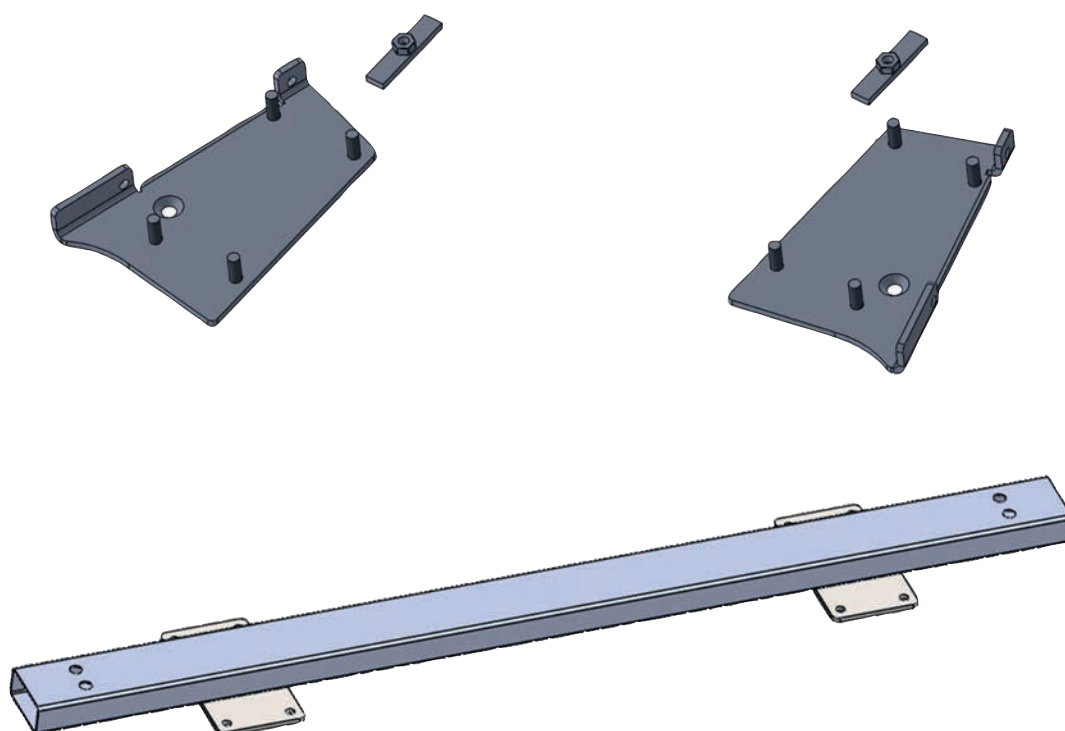

FI- KÄYTTÖOHJE

ETUSOVITIN DUCATO X290

VAIHE 1:



Poista kumitulppa.

VAIHE 2:



Aseta asennuslevy nelikulmaiseen reikään.

VAIHE 3:

Aseta asennuslevy niin, että ruuvireikä on keskellä alustan nelikulmaista reikää.

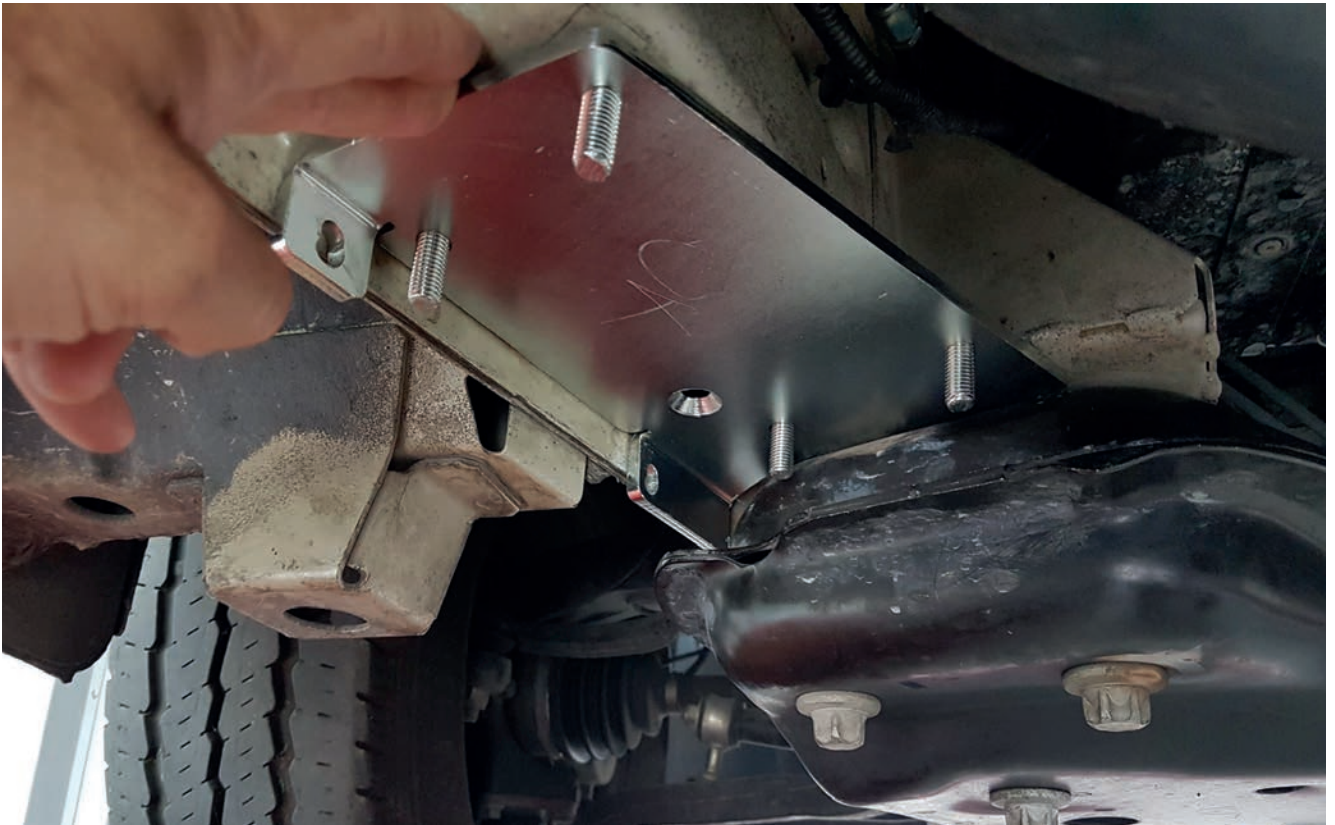
VAIHE 4:

Työnnä sovitin mahdollisimman pitkälle eteenpäin.

VAIHE 5:

Kiinnitä sovitin reikään työnnettyllä asennuslevyllä.

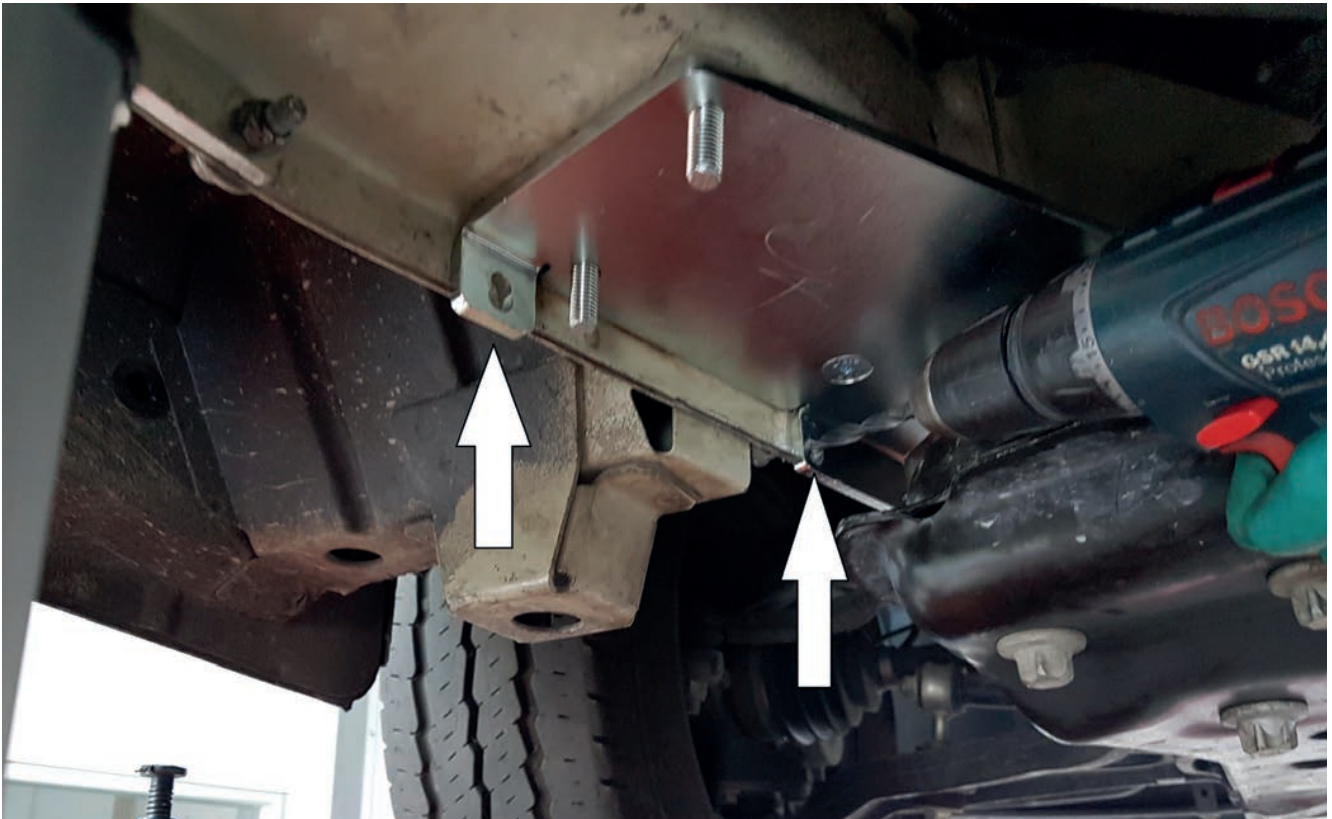
VAIHE 6:

Poraa kaksi 8 mm:n reikää.

VAIHE 7:

Kiinnitä sovitinlevy kahdella M8-pultilla alustaan.

VAIHE 8:

Löysää tarvittaessa säiliötä tukevia pultteja ja siirrä sitä muutaman senttimetrin verran kohti ajoneuvon keskiosaa.

HUOMIO! MOOTTORITUNKKI ON SUUNNATTAVA AJONEUVON KESKELLE, MUTTA SEN ON PITÄVÄ KÄÄNTYÄ TAAKSEPÄIN.

Takasovitin Ducato X250 (taka-akselin edessä)

VAIHE 1:

Taka-adapteri on asetettava taka-akselin eteen alla olevan kuvan osoittamaan paikkaan.

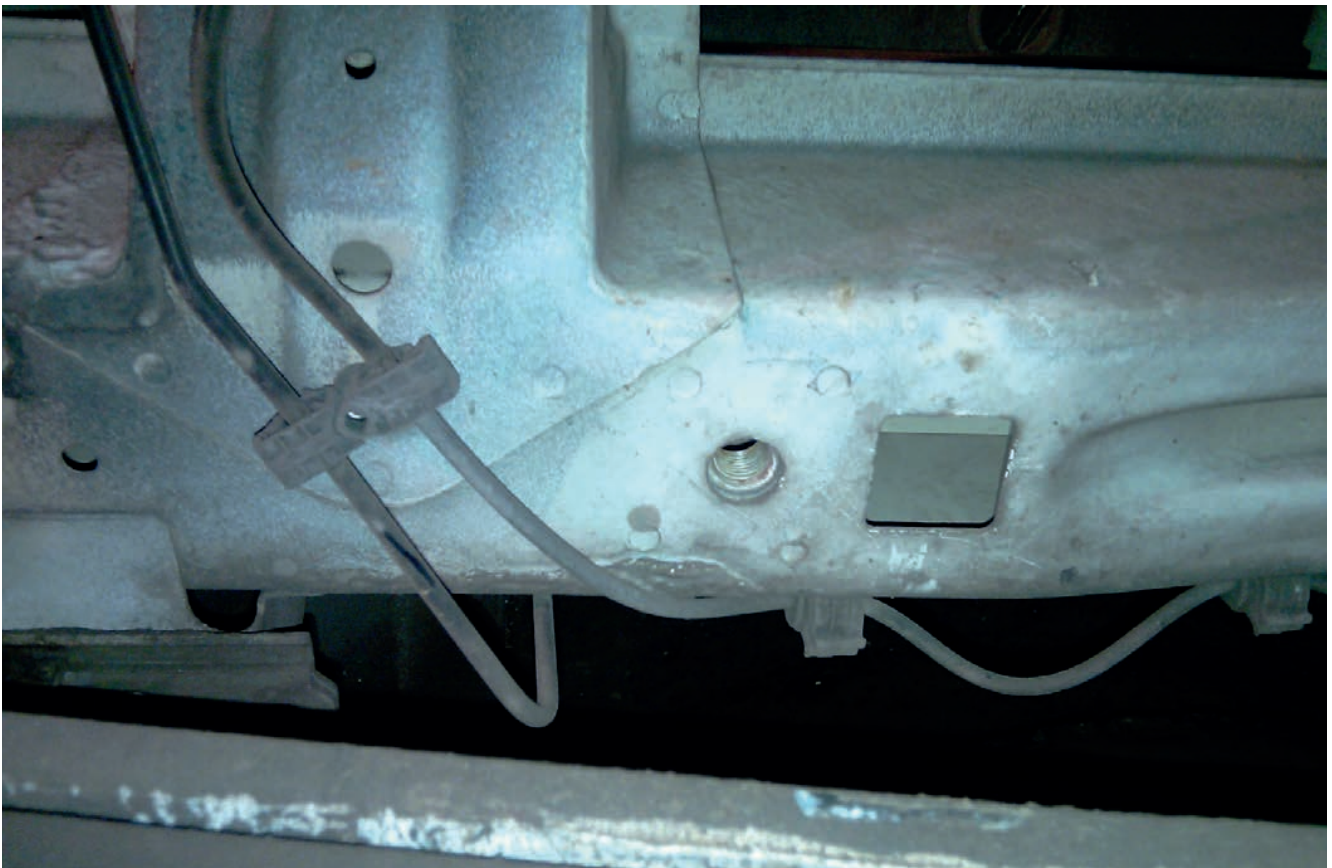

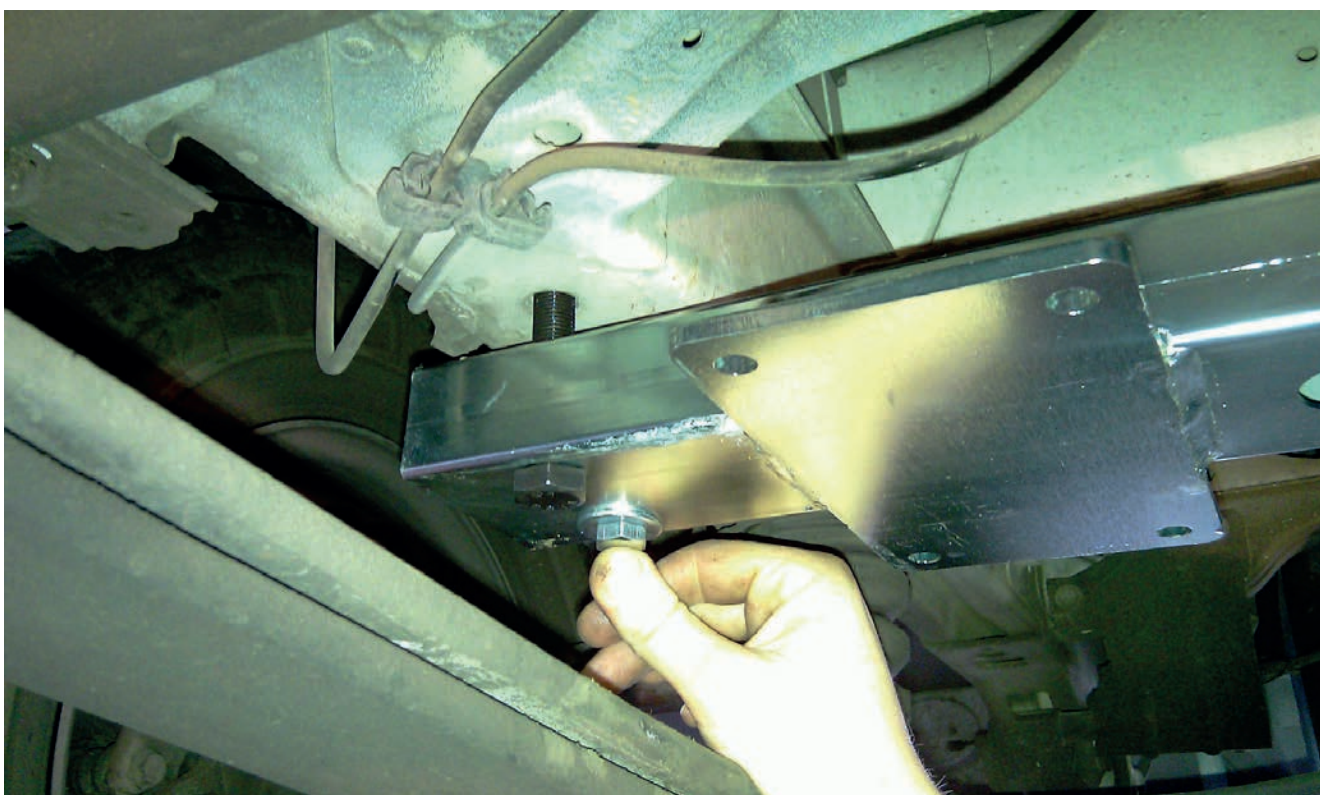
VAIHE 2:

Aseta asennuslevy paikalleen (levy, jossa on vain yksi reikä) ja kiinnitä se 10 x 70 mm ja 14 x 70 mm pulteilla.

HUOMIO: MOLEMPIEN TAKAMOOTTORITUNKKIEN ON OLTAVA AJONEUVON KESKELLE PÄIN, MUTTA NIIDEN ON VOITAVA KÄÄNTYÄ ETEEN PÄIN.

VAIHE 3:

Takasovitin on asetettava taka-akselin taakse alla olevien kuvien osoittamaan paikkaan, aseta tiivistyslevyt (kahdella reiällä) ja kiinnitä huomiota sähköjohtoihin; tarvittaessa siirrä niitä ja aseta sovitin niihin (katso toinen kuva alla).





Siirrä sähköjohto sivuun ja aseta sitten sovitin paikalleen.



VAIHE 4:

Kiinnitä sovitin neljällä 10 x 70 mm:n pultilla ja kiinnitä sitten tunkit.

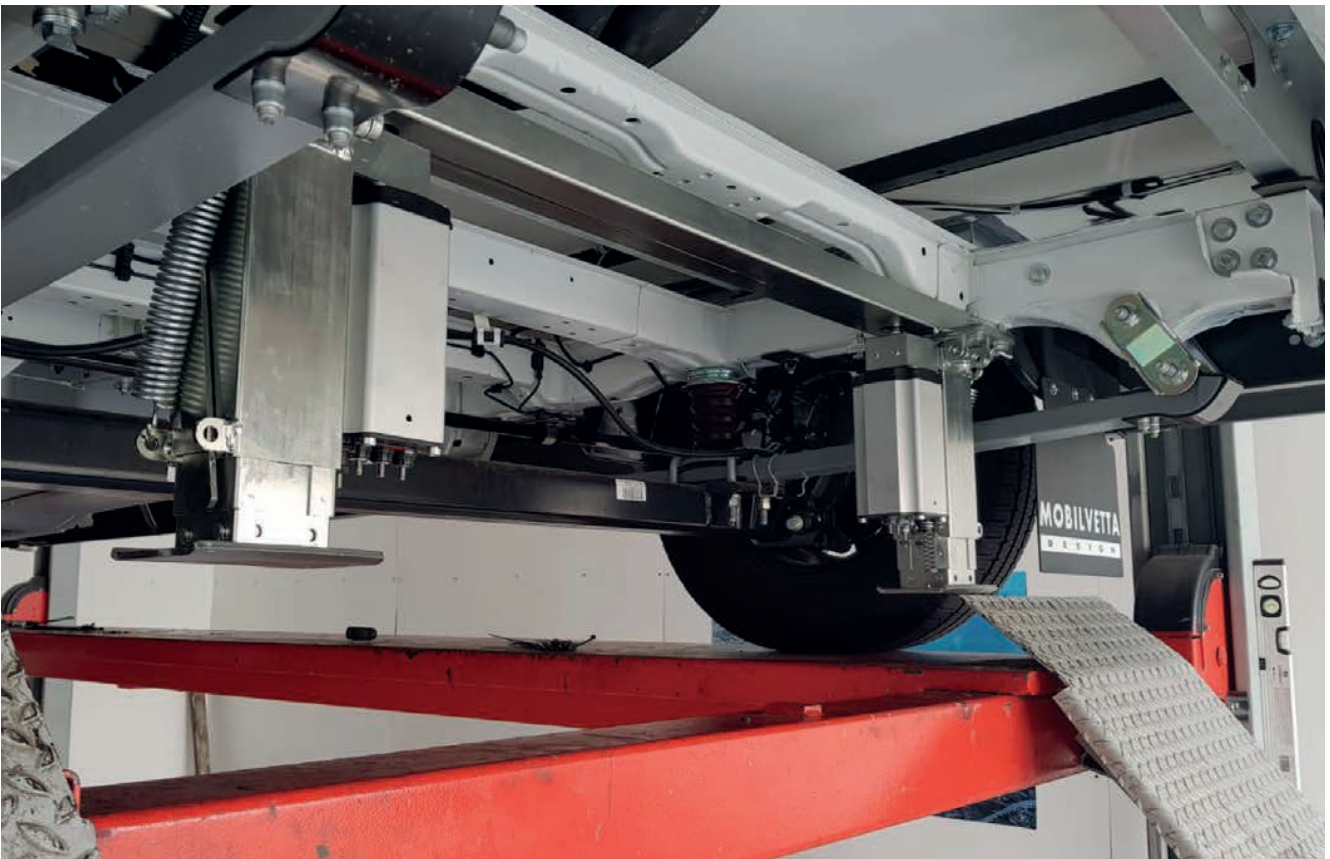

HUOMIO: MOLEMPIEN TAKAMOOTTORIN TUNKKIEN ON OSOITETTAVA AJONEUVON KESKELLE, MUTTA NIITÄ ON VOITAVA KÄÄNTÄÄ ETEEN TAI TAAKSE.

CARBEST
INNOVATIONS FOR MOBILE LIFE

Autolift System

ADAPTER TIL DUCATO X290

Art. 465113

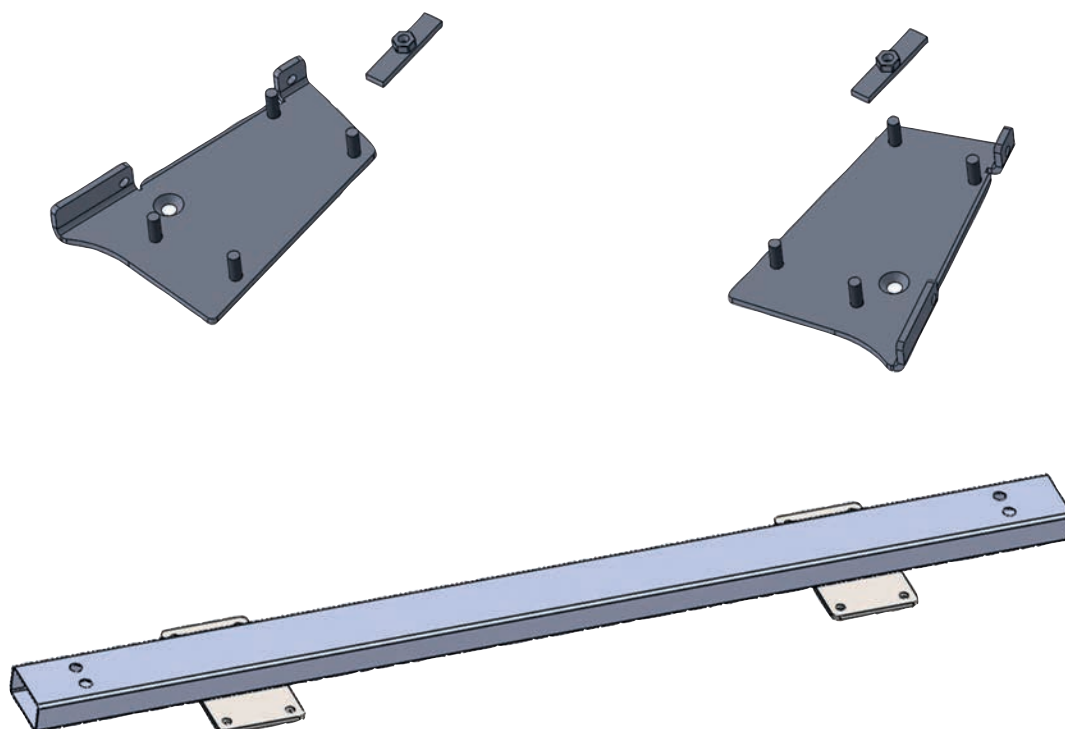

DK – BRUGERHÅNDBOG.

FRONT ADAPTER DUCATO X290

TRIN 1:



Fjern gummistopperen.

TRIN 2:



Indsæt monteringspladen i det firkantede hul.

TRIN 3:

Indsæt monteringspladen med skruetullet koncentrisk med det firkantede hul i chassiset.

TRIN 4:

Skub adapteren så langt fremad som muligt.

TRIN 5:

Fastgør adapteren med den monteringsplade, som du har sat i hullet.

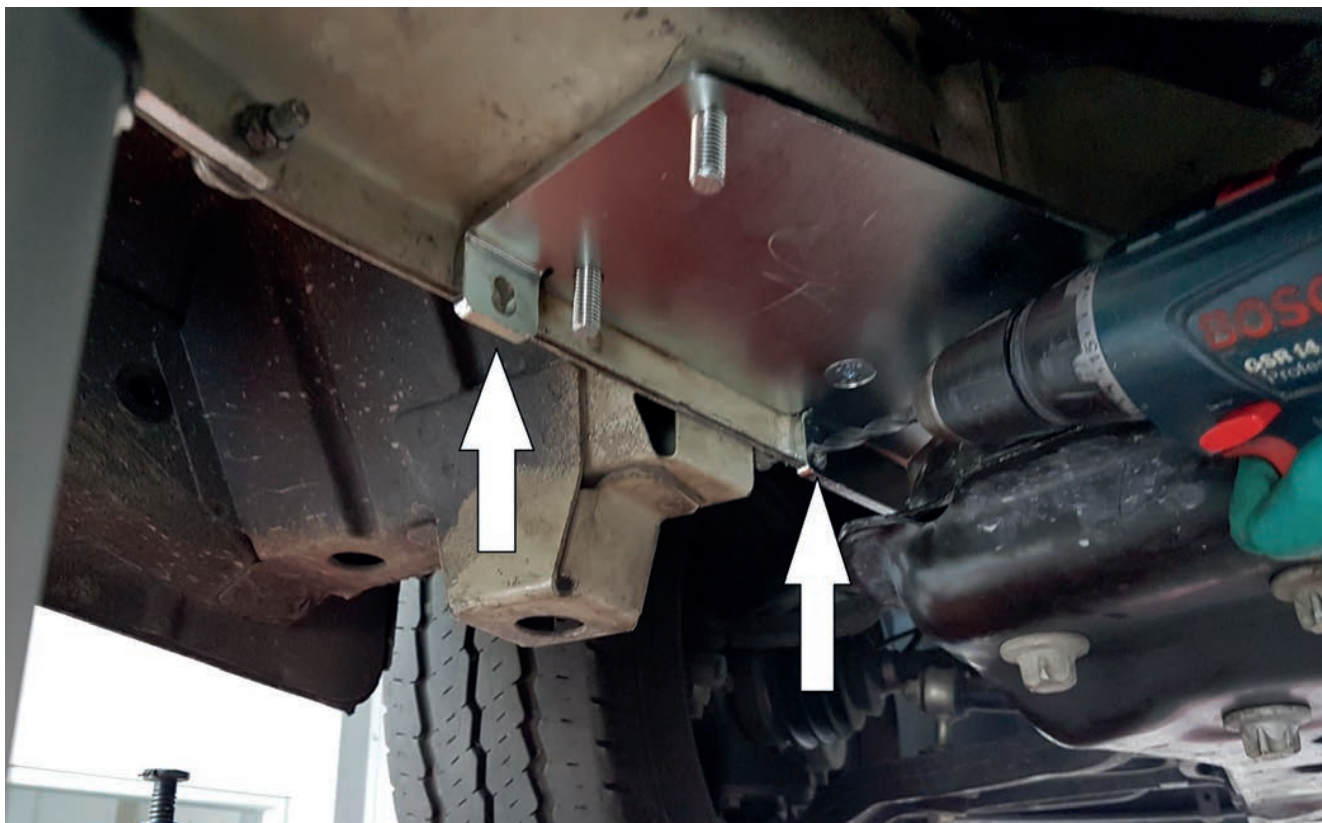
TRIN 6:

Bor to 8 mm huller.

TRIN 7:

Fastgør adapterpladen med to M8-bolte på chassiset.

TRIN 8:

Hvis det er nødvendigt, skal du løsne boltene, der støtter tanken, og flytte den et par centimeter mod midten af køretøjet.

OBS: MOTORVOGNE SKAL VENDE MOD MIDTEN AF KØRETØJET, SAMTIDIG MED AT DEN SKAL KUNNE DREJES MOD BAGDELEN.

Bagadapter Ducato X250 (foran bagakslen)

TRIN 1:

Den bageste adapter skal placeres før bagakslen, på det sted, der er vist på billedet nedenfor

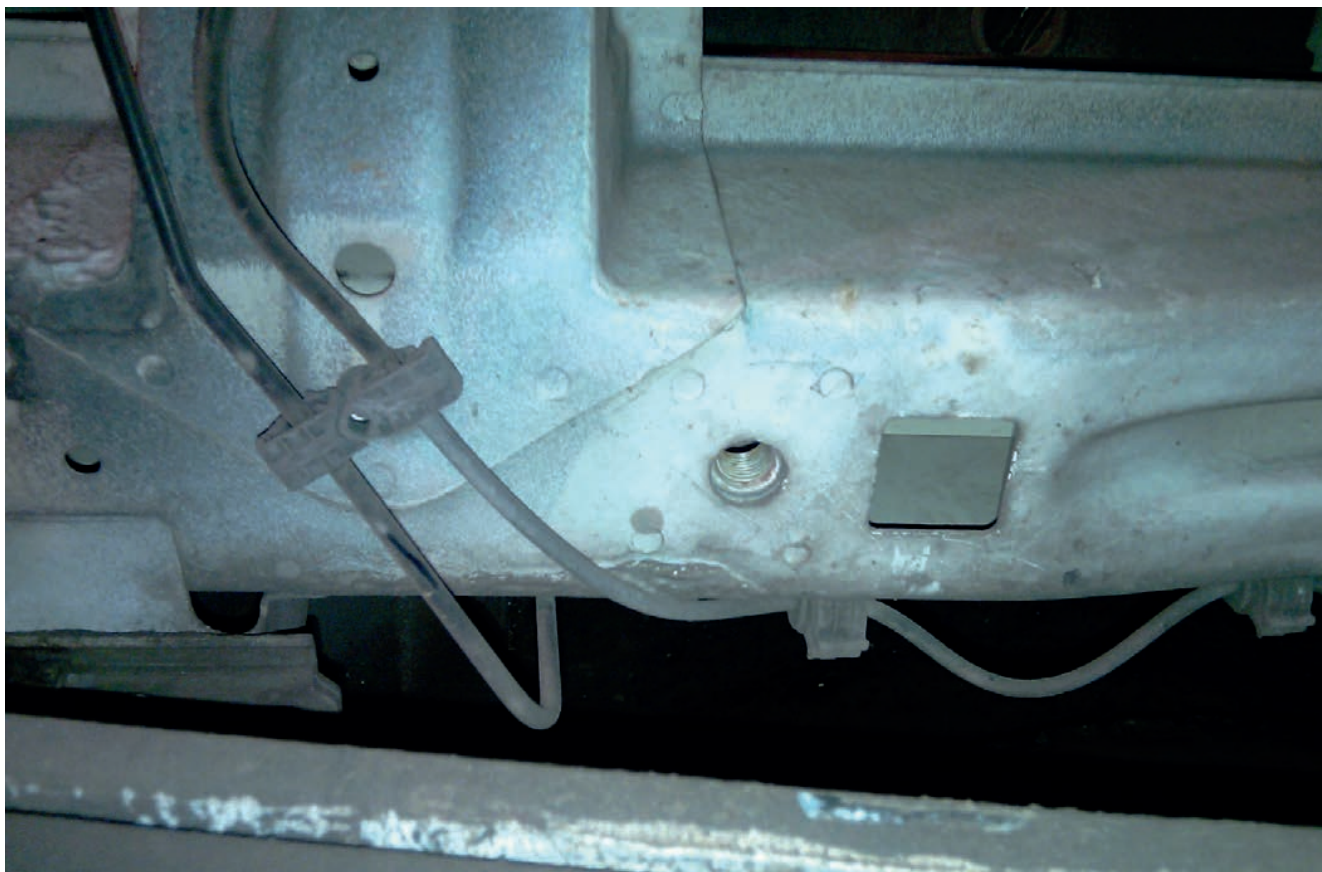

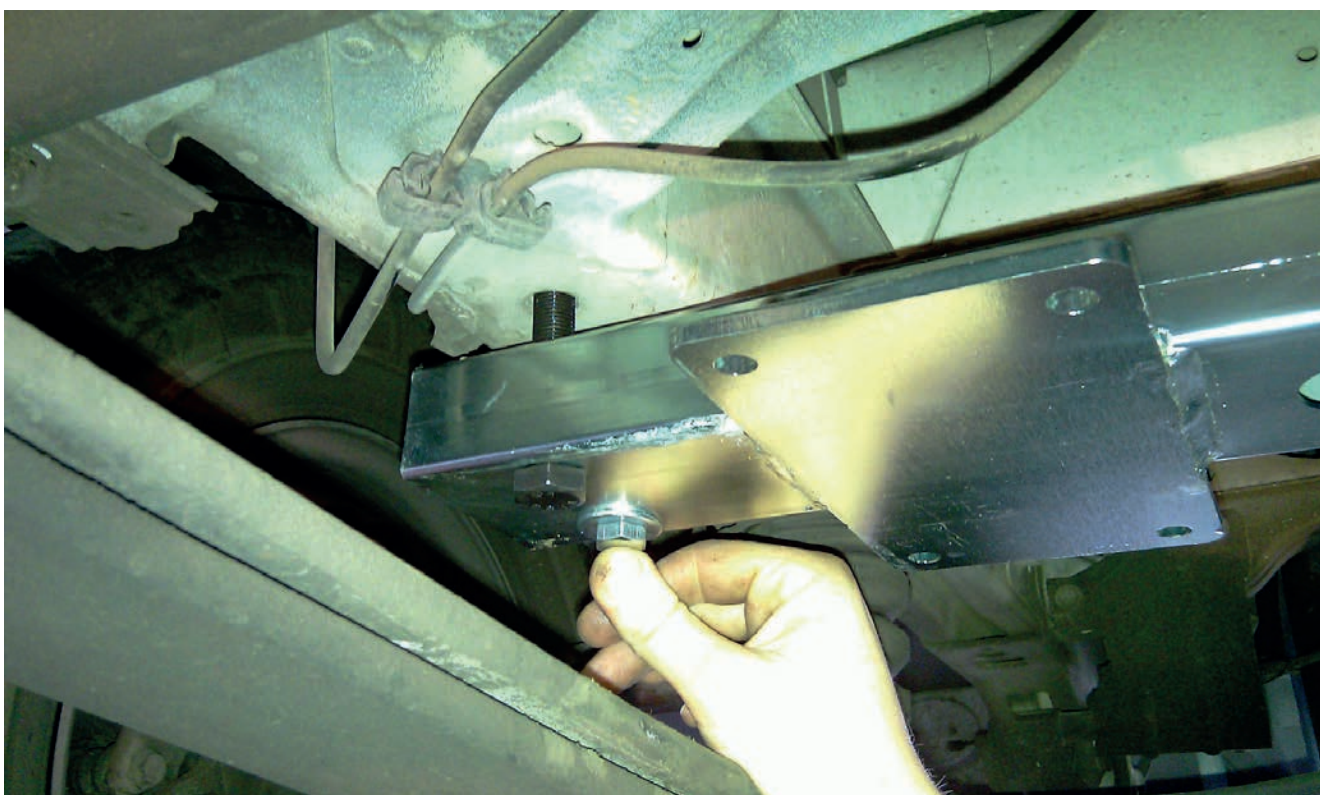
TRIN 2:

Indsæt og placer monteringspladen (pladen med kun ét hul), og fastgør den derefter med 10 x 70 mm og 14 x 70 mm bolte.

OBS: BEGGE BAGESTE MOTORDREV SKAL VENDE MOD MIDTEN AF KØRETØJET, SAMTIDIG MED AT DE SKAL KUNNE DREJE MOD FRONTEN.

TRIN 3:

Den bageste adapter skal placeres bag bagakslen på det sted, der er vist på billederne nedenfor, indsæt tætningspladerne (med to huller), og vær opmærksom på de elektriske ledninger; flyt dem om nødvendigt, og sæt adapteren ind i dem (se andet billede nedenfor).





Flyt de elektriske ledninger til siden, og sæt derefter adapteren i.



TRIN 4:

Fastgør adapteren med 4 bolte på 10 x 70 mm, og fastgør derefter donkraften.

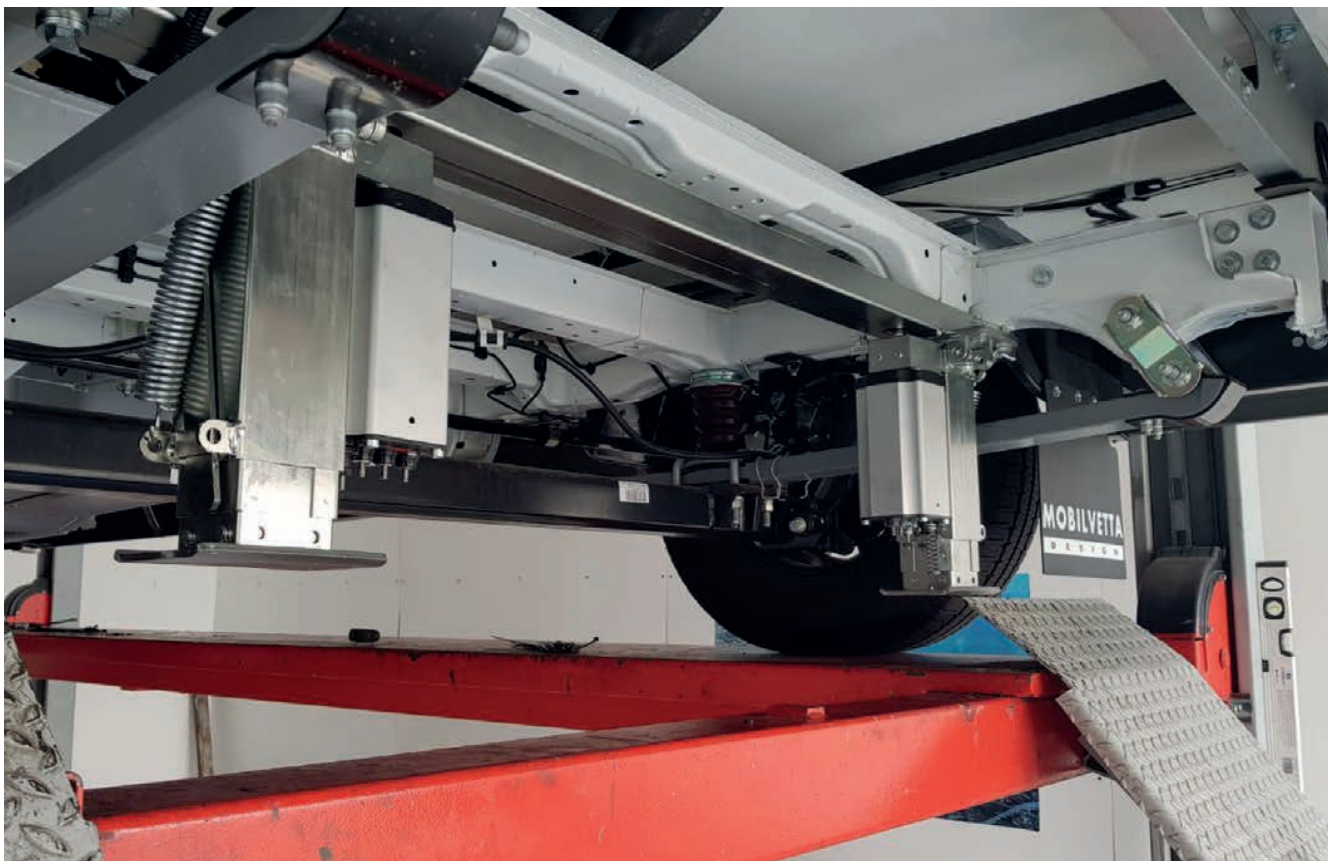

OBS: BEGGE BAGESTE MOTORDREV SKAL VENDE MOD MIDTEN AF KØRETØJET, SAMTIDIG MED AT DE SKAL KUNNE DREJES MOD FOR- ELLER BAGUD.

CARBEST
INNOVATIONS FOR MOBILE LIFE

Autolift System

ADAPTER FÖR DUCATO X290

Art. 465113

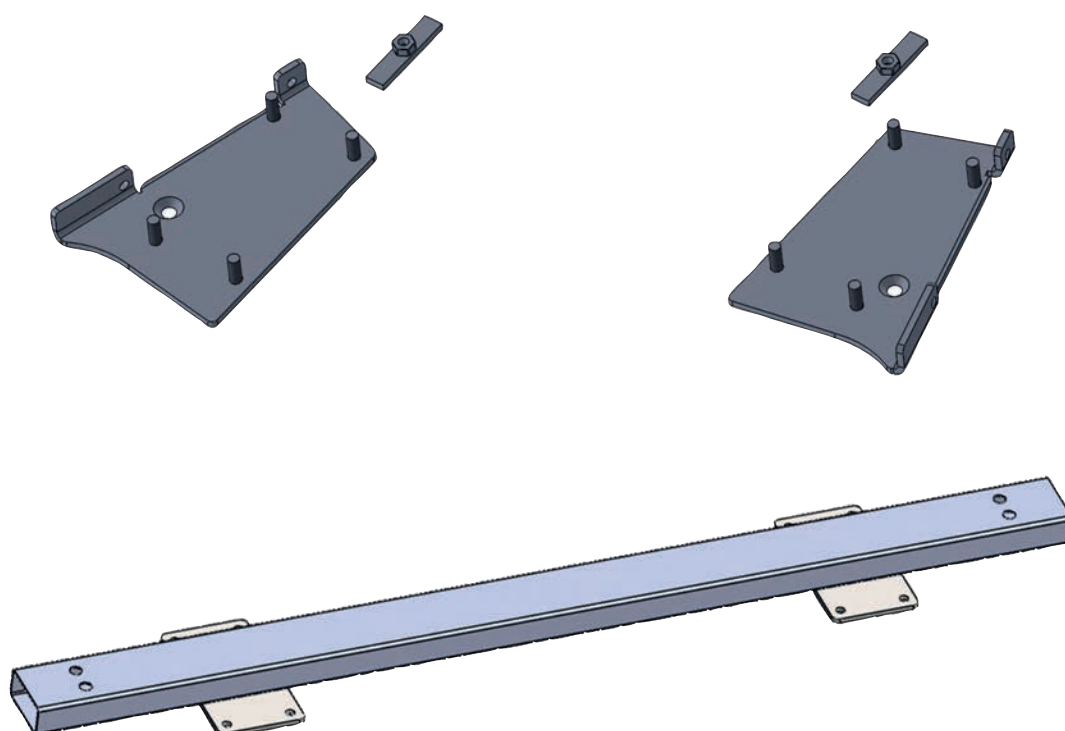

SE - ANVÄNDARMANUAL

FRÄMRE ADAPTER DUCATO X290

STEG 1:



Ta bort gummiproppen.

STEG 2:



Sätt in monteringsplattan i det fyrkantiga hålet.

STEG 3:

Sätt in monteringsplattan så att skruvhålet är koncentriskt med det fyrkantiga hålet i chassit.

STEG 4:

Skjut adaptern så långt framåt som möjligt.

STEG 5:

Fäst adaptern med monteringsplattan som du satte in i hålet.

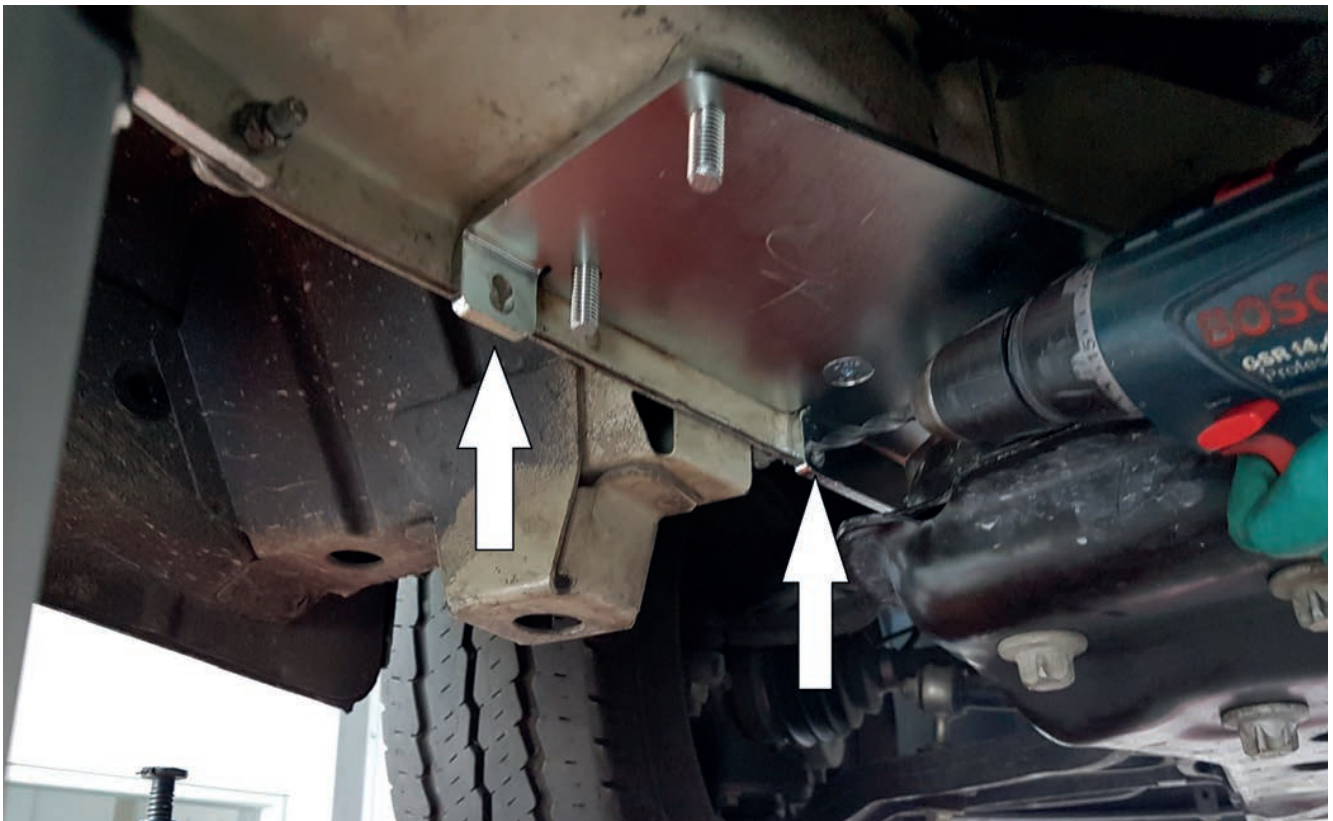
STEG 6:

Borra två 8 mm hål.

STEG 7:

Fäst adapterplattan med två M8-bultar på chassit.

STEG 8:

Om det behövs, lossa skruvarna som stöder tanken och flytta den några centimeter mot fordonets mitt.

OBS: MOTORHISSEN SKA VARA RIKTAD MOT FORDONETS MITT, SAMTIDIGT SOM DEN SKA KUNNA ROTERA MOT BAKSIDAN.

Bakre adapter Ducato X250 (framför bakaxeln)

STEG 1:

Den bakre adaptern måste placeras före bakaxeln, på den plats som visas på bilden nedan

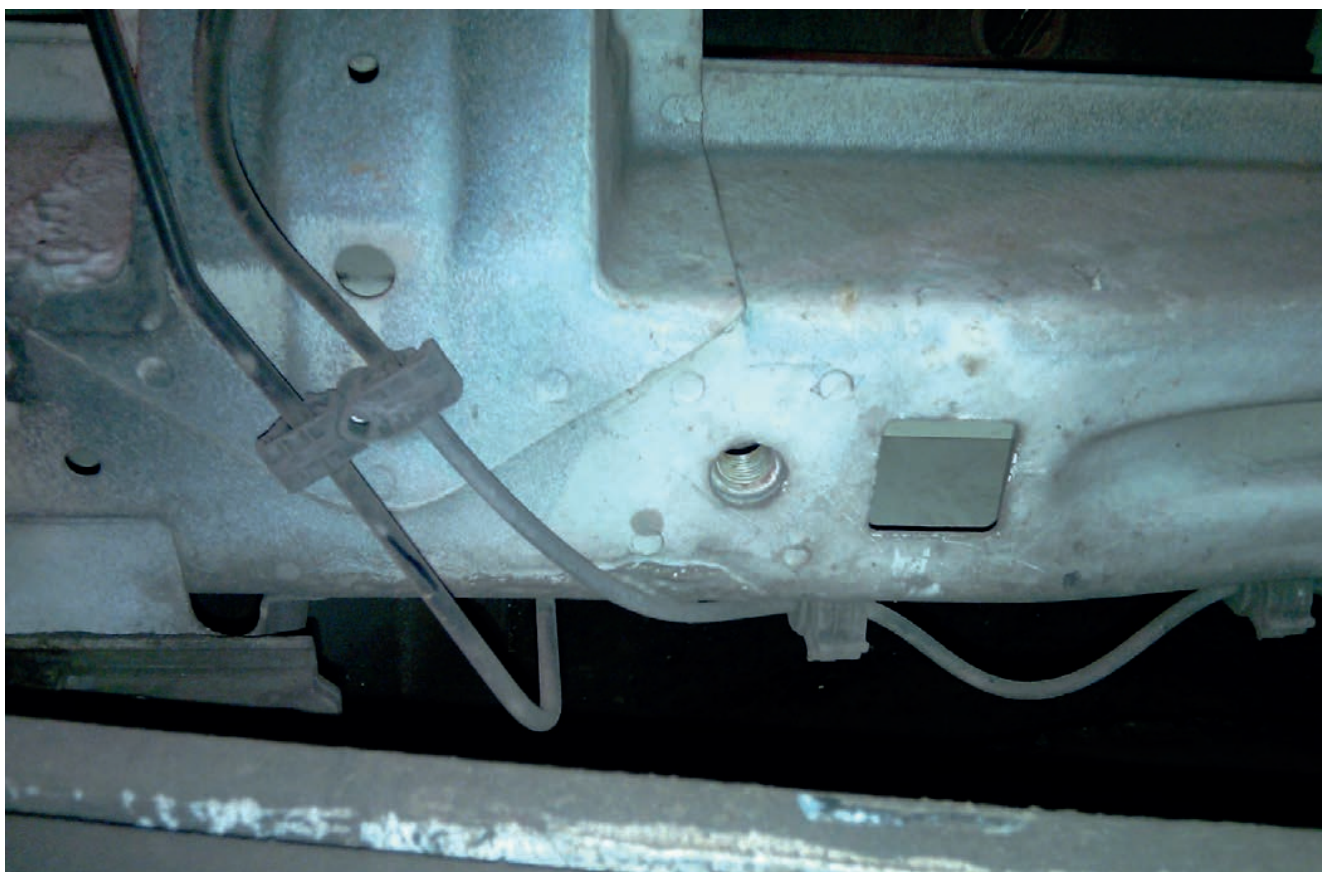

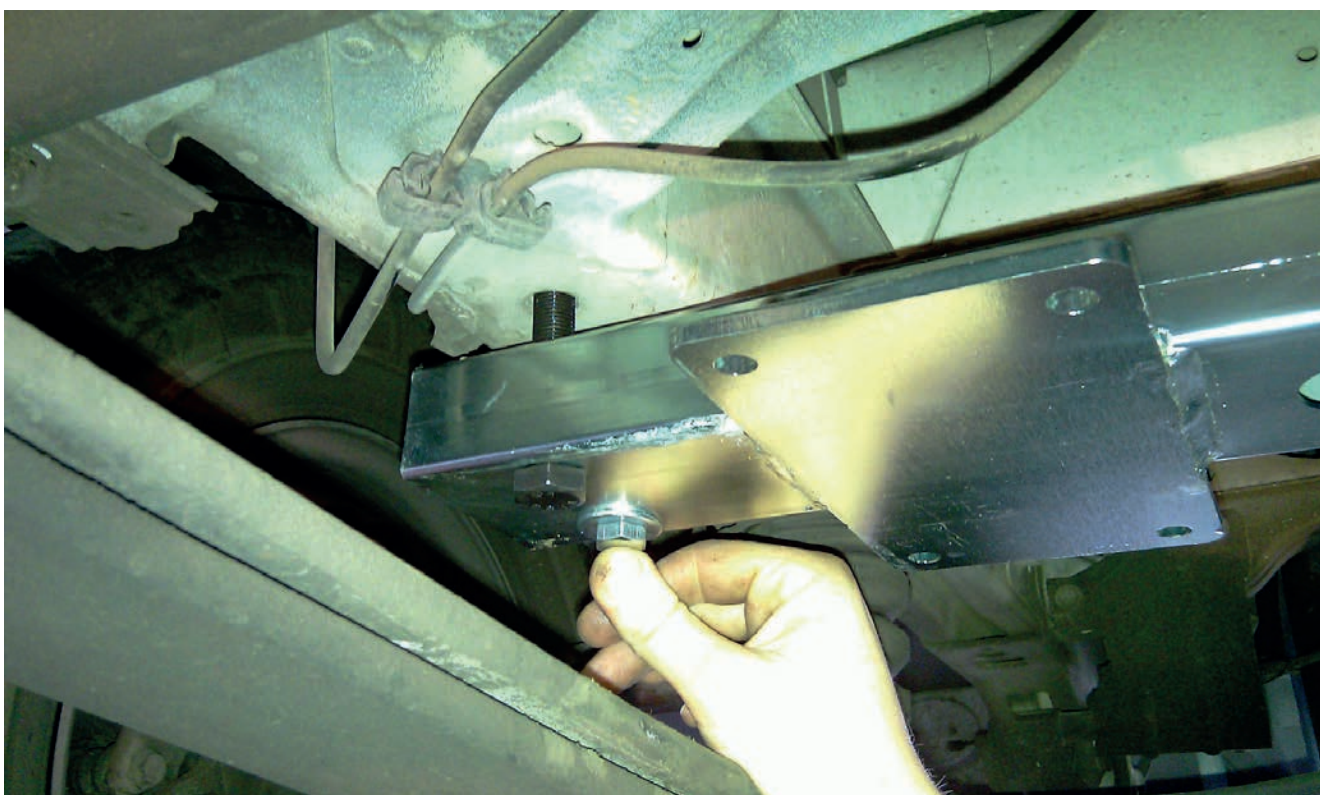
STEG 2:

Sätt in och placera monteringsplattan (plattan med endast ett hål), fortsätt sedan med att fästa den med 10 x 70 mm och 14 x 70 mm bultar.

OBS: BÅDA DE BAKRE MOTORJOCKARNA SKA VARA RIKTADE MOT FORDONETS MITT, SAMTIDIGT SOM DE SKA KUNNA ROTERA MOT FRAMSIDAN.

STEG 3:

Den bakre adaptorn måste placeras bakom bakaxeln på den plats som visas på bilderna nedan, sätt in tätningsslattorna (med två hål) och var uppmärksam på den elektriska ledningen; flytta den vid behov och sätt in adaptorn i den (se andra bilden nedan).





Flytta den elektriska ledningen åt sidan och sätt sedan in adaptern.



STEG 4:

Fäst adaptorn med 4 bultar 10 x 70 mm och fäst sedan domkrafterna.

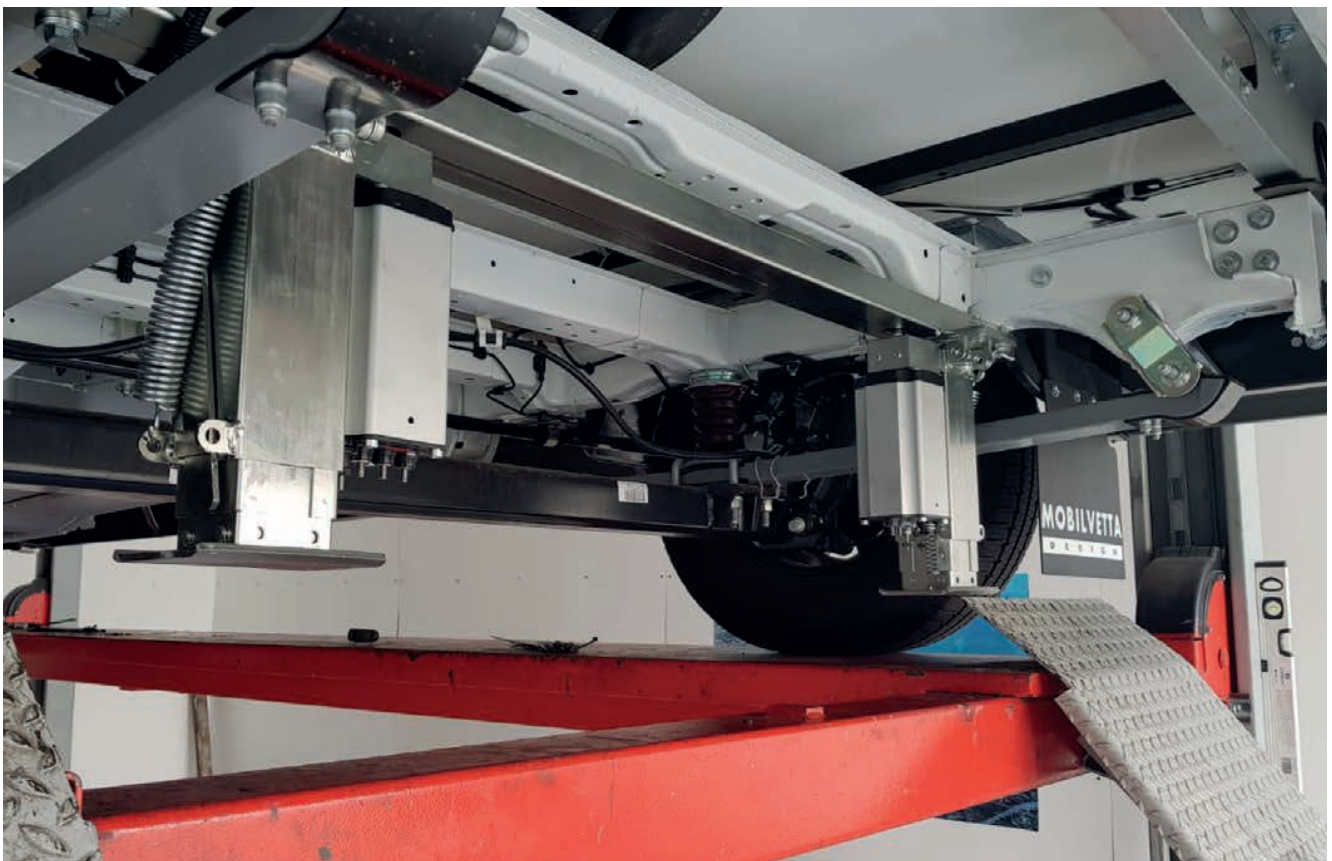

OBS: BÅDA DE BAKRE MOTORJOCKARNA SKA VARA VÄNDA MOT FORDONETS MITT, SAMTIDIGT SOM DE SKA KUNNA ROTERA MOT FRAMSIDAN ELLER BAKSIDAN.



REIMO REISEMOBIL-CENTER GMBH
63329 EGELSBACH · BOSCHRING 10 · GERMANY · WWW.REIMO.COM
MADE IN ITALY · © REIMO 02/2023